

NAOMI SYSTEM **User Guide**

308AR08002_1403

Thank you for purchasing Multi CCD Imaging Sensor Digital Radiography NAOMI.
Please read through this user guide carefully to ensure safe usage.

This user guide is for the following version of the NAOMI software.

Ver.9.35.0 or above

Check the software version on the included System Application / Driver CD-ROM or the software version information located on the lower right corner of the NAOMI software window.
If your software is not corresponding to the software version above, contact RF Technical Support Center.

Multi CCD Imaging Sensor
Digital Radiography

NAOMI

- 2001
- 2002
- 2004
- 2006

User Guide Index

1. Introduction		PDF Page
Precautions for Safe Use	Introduction 01	05
EMC (Electromagnetic Compatibility) Standards Description	Introduction 06	10
Specifications / Performance	Introduction 09	13
Appearance / Dimensions	Introduction 10	14
Packaged Items	Introduction 11	15
Features	Introduction 12	16
Setup the NAOMI Sensor	Introduction 13	17
2. Installation		
Installation Steps	Installation 01	19
Install the NAOMI Driver (XP)	Installation 02	21
Install the NAOMI Driver (Vista / Windows 7)	Installation 07	25
Install the NAOMI Imaging Software	Installation 11	29
Copy the NAOMI Imaging Data	Installation 16	34
3. Operation Check		
Operation Check	Operation Check 01	41
1. Set up the NAOMI Sensor	Operation Check 02	42
2. Confirm the Irradiation Area	Operation Check 03	43
3. Set the Calibration Scale	Operation Check 04	44
4. Set the X-Ray Exposure Factors	Operation Check 04	44
5. Start the NAOMI Software	Operation Check 05	45
6. Capture the X-Ray Image of the Calibration Scale	Operation Check 05	45
7. Confirm if the Calibration is Necessary	Operation Check 06	46
Ready to Use	Operation Check 07	47
4. Software		
NAOMI Software	Software 01	49
A. Capture / Manipulation Mode	Software 02	50
Menu Bar Icons	Software 03	51
B. Patient Information Mode	Software 04	52
1. Before Capturing the X-Ray	Software 05	53
2. How to Capture X-Ray Images	Software 08	56
3. Zoom In / Out on the X-Ray Images	Software 15	63
4. Move the Image	Software 16	64
5. Adjust the Brightness / Contrast	Software 17	65
6. Adjust Gamma Setting	Software 18	66
7. How to Adjust the X-Ray Images	Software 19	67
8. How to Edit Patient Information or X-Ray Technique Records	Software 21	69
9. How to Add L or R Marking	Software 22	70
10. How to Save the Adjusted Image	Software 23	71
11. How to Save as a Different File Format	Software 24	72

12. How to Open the Saved Image	Software 25	73
13. How to Close the Selected Image	Software 27	75
14. How to Print the Selected Image	Software 28	76
15. How to Burn X-Ray Images on to a CD-ROM (windows XP).....	Software 29	77
How to Burn X-Ray Images on to a CD-ROM (windows 7).....	Software 32	80
16. How to Reverse Negative / Positive	Software 35	81
17. How to Invert the Selected Image	Software 36	84
18. How to Rotate the Selected Image.....	Software 37	85
19. How to Turn On / Off the Enhancement	Software 38	86
20. How to Change the Display Mode on Screen	Software 39	78
21. How to Open / Close Annotation Menu	Software 41	89
22. Annotation Menu.....	Software 42	90
Pan Window (Navigation Window)	Software 43	91
A. Draw a Straight Line / Arrow / Polyline.....	Software 44	92
B. Draw a Shape	Software 46	94
C. Draw a Curved Line / Shape	Software 48	96
D. Insert the Text or Note	Software 50	98
E. Measure the Length	Software 51	99
F. Measure the Angle	Software 52	100
G. Select the Annotation Object	Software 53	101
23. How to Change the Setting	Software 54	102
24. How to Close the NAOMI Software	Software 59	106

5. Calibration / QAP (Quality Assurance Program)

Calibration / QAP (Quality Assurance Program).....	Calibration / QAP 01	109
Positioning Calibration	Calibration / QAP 02	110
Luminance Calibration	Calibration / QAP 07	115

6. Trouble Shooting Guide

Calibration / QAP (Quality Assurance Program).....	Calibration / QAP 01	113
Positioning Calibration	Calibration / QAP 02	114
Luminance Calibration	Calibration / QAP 07	119

Setup / Installation

The NAOMI sensor does not work.	01	121
I cannot install the software to my computer.	02	121
Installation Wizard does not come up.	02	122
I want to uninstall the software.	02	122
I want to reinstall the software.	02	122
I want to install the software to my second computer.	02	122
I cannot install the driver for the NAOMI sensor.	03	123
I cannot find the map data folder.	03	123

Capturing X-Ray Images

It starts reading the data without the irradiation.	04	124
It takes longer than 1 minute for images to come up to the screen.	05	125
It does not start reading the data after the irradiation.	05	125
The message "Please irradiate X-ray" appears twice.	06	126
I took an x-ray image with a wrong ID number/name.	07	126
Do you have the CD-ROM icon on the top?	08	127

Calibration / QAP (Quality Assurance Program)

I got the error message during Positioning Calibration.	10	129
I got the error message, during Luminance Calibration.	13	132

Open / Save

I cannot save images.	15	134
I cannot open the saved images.	15	134
I don't know where to find the save image.	15	134

Crash

The NAOMI software crashes (closes by itself).	16	135
---	----	-----

7. Appendix

Quick Manual		
Manipulating the captured images... ..		136
Capturing X-Ray Images		137
How to correct when I captured the image with a wrong ID?		138
Safety Check		140
RF Technical Support Center.....		141
Technical Support Request Form		142
NAOMI Technique Indication Chart.....		146

Introduction

This section contains the important information on safe use, features and setup instruction.

PURPOSE OF USE

This product holds the planate x-ray incident surface and captures the transmissive image, which the scintillator translated by reacting to the radiation exposed from a medical x-ray generator and gone through a patient, with CCD cameras. The CCD cameras convert each pixel of the image into an electric signal and exports to the externally-connected computer in order to display the image onto the viewing monitor.

This product is also intended to store and maintain these captured images to help make the diagnosis and assist to provide more smooth explanation to patients for their better understandings.

Precautions for Safe Use

NAOMI is designed at the full attention for safety measures to avoid any accidents with proper use. It also complies with the following safety standards for medical devices.

IEC60601-1 : 2005 (JIS T 0601-1 : 2012)

IEC60601-1-2 : 2007

Be sure to read and understand the Precautions for Safe Use section thoroughly for proper and safe use.



An electric device may cause a fire or a fatal accident if it is not used properly.

Warning Labels

This user guide uses the following warning labels. Before reading the contents, fully understand the meaning of the label.



If this warning label and contents were ignored, it could lead to a possibility of a fatal accidents such as a fire or an electric shock, or severe injury to users or patients.



If this caution label and contents were ignored, it could lead to a possibility of an accident injuries of users or patients or damages to the surroundings.



Prohibited



Dismantle
Prohibited



Wet Contact
Prohibited

Precautions for Safe Use

Information on Handling



NAOMI must be operated by a medical doctor or medical personnel who is under the supervision of a medical doctor.

Misusage by a patient may cause an electric shock.



Prohibited

Do not use along with self-contained or wearable medical device.

Do not use NAOMI with any self-contained medical devices such as pacemaker and self-contained defibrillator, or wearable medical device such as electrocardiograph. It may cause malfunctioning on these medical devices.



Prohibited

Do not use NAOMI close to where cell phones are in use.

It may cause malfunctioning or damages to the product.
Maintain the recommended distance by EMC Standards from such devices.



Prohibited

NAOMI should not be used adjacent to or stacked with other equipment.

It may cause malfunctioning or damages to the product.
If adjacent or stacked use is necessary, the NAOMI should be observed to verify normal operation in the configuration in which it will be used.



Wet Contact
Prohibited

Do not touch the power plug the DC jack or the USB port with wet hands.

It may cause an electric shock.



Prohibited

Do not put a finger into the DC jack or a the USB port.

It may cause a fire, an electric shock or a damages to the product.



CAUTION

In case of following damages...

- NAOMI is damaged.
- Smoke reeked up from NAOMI.
- NAOMI has unusual noise or odor.
- Water or liquid seeped into NAOMI.
- NAOMI was dropped

Take the following measures

1. Stop using NAOMI immediately.
2. Unplug the power cable, AC adapter and USB cable.
3. Contact RF Technical Support Center.



CAUTION

Use caution on losing the image data.

NAOMI is programmed to automatically store the captured images into the computer hard drive. However, if there was a power loss such as power outage during the capturing process, the image cannot be automatically stored. Also, if the file name or storage location is incorrect it may cause the image data loss. To avoid the data loss, read the "Software" or "Troubleshooting" section on this user guide prior to use.



CAUTION

The measured value of length and angles on the NAOMI software is only for reference.

Some error may be observed depending on the tube distance to NAOMI or thickness of subject. Use the measured results only for reference.



WARNING

In order to avoid electric damages, this device should only be connected to the power connector (commercial) which is equipped with the ground.

Precautions for Safe Use

Information on Handling



Prohibited

Do not drop or give strong impact onto NAOMI.

It may cause a fire, an electric shock or damages to this product.



Prohibited

Do not directly stand on NAOMI.

It may damage this product and may cause injuries.



Dismantle
Prohibited

Do not dismantle or modify the product.

Do not open the case. It is dangerous to touch the internal components, and may cause damages. If the product case is opened, the product warranty is voided regardless of the remaining warranty term.



Prohibited

Avoid dust to be collected around the DC jack or the USB port.

It may cause a fire, an electric shock, or damages to this product.
Inspect and clean the area regularly.



Prohibited

Do not spray, pour or spill any liquid onto NAOMI, its AC adapter or its cables.

It may cause a fire, an electric shock or damages to this product.



Prohibited

Do not use any organic solvent or chlorine bleach on NAOMI.

It may damage this product.

To clean the product, wipe with a soft cloth damped with diluted mild detergent.



Prohibited

Do not use in any sterilizer such as Autoclave.

This product does not contain any materials or components, which require sterilization.
It is not necessary to sterilize this product.



CAUTION

To disinfect NAOMI, wipe with a soft cloth damped with disinfective ethyl alcohol.



Unplug

Unplug the power cable from the power outlet if this product is not in use for a long time.



Prohibited

Avoid transport or storage of this product in the following environment.

- Temperature: Lower than -5°C(23°F) or higher than 50°C(122°F)
- Humidity: Less than 20% RH or more than 80% RH
- Atmospheric pressure: Less than 75kPa (750mB) or more than 106kPa(1060mB)



CAUTION

To dispose NAOMI, follow the waste disposal regulations in each local government and prevent any environmental destruction.



CAUTION

When leaving the office at the end of the day, please

- Close the software
- Turn off the PC
- Unplug the AC Adaptor

Precautions for Safe Use

Information on Installation



CAUTION

Install this device in the way that patients do not touch the bottom of the device.



Prohibited

Avoid installation of this product in the following environment.

- Temperature: Lower than 15°C(59°F) or higher than 35°C(95°F)
- Humidity: Less than 30% RH or more than 70% RH
- Atmospheric pressure: Less than 75kPa(750mB) or more than 106kPa(1060mB)
- Places where water may splash
- Environment with a sudden and extreme temperature change or condensation
- Near heat generating units (stove, heater, etc.)
- Dusty area
- Places with strong vibration or unstable or sloping ground
- The place where gets direct sunlight

It may cause a fire, an electric shock or damages to this product.



Prohibited

Use the enclosed power cable, AC adapter and USB cable only.

It may cause a fire, an electric shock, damages or system failure if any other AC adapter or cables were used.



Prohibited

Avoid damaging the cables.

- Avoid the cables being caught in between this product, the wall, shelves, or cabinets.
- Do not modify or damage the cables.
- Do not bend the cable forcibly. Do not place heavy items on the top of the cable.
- Avoid heating the cable or making the contact with heat generating device.
- Hold the jack or plug to unplug the cable and avoid pulling from the cable.

It may cause a fire, an electric shock, or damages to this product if the cables were damaged.

In case of damages on the cable, stop using this product immediately and contact RF technical support center.



WARNING

Keep the cables organized and untangled.

It may cause a fatal accident or serious injuries by being choked by the cable.

It may also cause the fall of this product by tangled cables.



Earthed

Connect the ground wire.

It may cause an electric shock if the ground cable is not connected.



WARNING

Install any electronic devices (such as a computer) with IEC60601-1 standards within the patient premises (as shown on the right).

NAOMI complies with IEC60601-1 standards and can be used within the patients premises. It may cause an injury such as an electric shock to patients if a device without such standards is used.

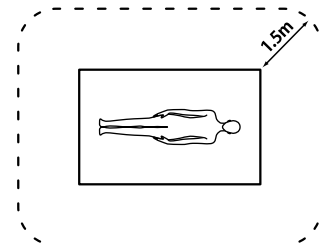

WARNING

Make sure that the devices meet following specifications when installing them outside of patients premises.

- Devices that conforms to the IEC60950
- No use of metal connector or using separator

If any device without such standards is used, it may cause an electric shock to patients by current leaking into NAOMI. Use a different electric transformer if it is necessary.



WARNING

Install the NAOMI with an upright stand with IEC60601-2-32 : EN60601-2-32 standards when the NAOMI needs to be installed on the upright position.

If any device without such standards is used, it may cause a drop of the NAOMI.



CAUTION

By removing the AC Adaptor from the power outlet, this device is completely separated from the electrical power. For the cases of emergency, do not use the output where the commercial outlet is unreachable or where AC Adaptor is not accessible to unplug from the power outlet.

Precautions for Safe Use

Information on Handing



CAUTION

Use one of the following operating systems:

Windows XP, Windows Vista, Windows 7 or Windows 8 (32bit and 64bit)

Any operating system other than above may not be able to run the NAOMI software.

Even if the NAOMI software worked on other operating systems, it may cause malfunctioning or damages.



CAUTION

Recommended computer environment is more than the following specifications.

CPU : Intel CORE 2 Duo 1GHz or higher (or equivalent)

Memory : 2GB or higher

Hard Disk Drive : 250 GB or more

Peripheral : USB 2.0 Port x 1

CD / DVD-ROM Drive x 1

Monitor : XGA Size (1024 x 768)



CAUTION

Set "Never" on Power Options on the computer and monitor.

- Turn off monitor
- Turn off hard disks
- System standby
- System hibernate

It may cause malfunctioning or slow down of the system.



CAUTION

Do not run other software on the same computer while NAOMI is running.



CAUTION

Do not connect the Internet on the computer with which the NAOMI is used.

It may cause a malfunction of the computer from the computer virus.

EMC (Electromagnetic Compatibility) Standards Description

The followings are to provide the information of electromagnetic environment based on IEC60601-1-2:2007 Clause 5.2.2. to the NAOMI users.

What is EMC (Electromagnetic Compatibility)?

It is an equipment and its performance, which provide an ability to tolerate and function satisfactory (Immunity) without introducing electromagnetic disturbances (Emission) within the environment, which the equipment or system exist.

ESSENTIAL PERFORMANCE

The NAOMI holds the planate x-ray incident surface and captures the transmissive image, which the scintillator translated by reacting to the radiation exposed from a medical x-ray generator and gone through a patient, with CCD cameras. The CCD cameras convert each pixel of the image into an electric signal and exports to the externally-connected computer in order to display the image onto the viewing monitor.

The NAOMI is also intended to store and maintain these captured images.



CAUTION

The medical electrical equipment, NAOMI needs special precautions regarding EMC and needs to be installed and put into service according to the EMC information provided in this technical description.



CAUTION

Portable and mobile RF communications equipment can affect medical electrical equipment, NAOMI.



Prohibited

NAOMI should not be used adjacent to or stacked with other equipment.

If adjacent or stacked use is necessary, the NAOMI should be observed to verify normal operation in the configuration in which it will be used.



Prohibited

For items listed below, do not use any items other than what was supplied as a part of the NAOMI system.

If any items other than what was supplied as a part of the NAOMI system is used, it may exert a harmful influence to other electrical devices. It may also receive a harmful influence from other electrical devices and cause malfunctioning.

Item Name	Maximum Cable Length	Shielding	Model {Manufacturer}
AC Adapter	2.0m	N/A	MPU100-105 {Sinpro Electronics CO., Ltd.}
Power Cable	1.75m	N/A	LT-832+501 {Lian Dung Electric Wire Material Co., Ltd.}
Power Cable	1.75m	N/A	VM0306B-0303B (Hirakawa New Tech)

NOTE: NAOMI complies with EMC standards with the items supplied as a part of the system.

Table 1 - Guidance and manufacturer's declaration - electromagnetic emissions -
for all EQUIPMENT and SYSTEMS (see 5.2.2.1c)

Guidance and manufacturer's declaration - electromagnetic emissions		
The NAOMI is intended for use in the electromagnetic environment specified below. The customer or the user of the NAOMI should assure that it is used in such an environment.		
Emissions test	The NAOMI	Electromagnetic environment - guidance
RF emissions CISPR11	Group 1	The NAOMI uses RF energy only for its internal function. Therefore, its RF emissions are very low and are not likely to cause any interference in nearby electronic equipment.
RF emissions CISPR11	Class B	The NAOMI is suitable for use in all establishments, including domestic establishments and those directly connected to the public low-voltage power supply net work that supplies buildings used for domestic purposes.
Harmonic emissions IEC61000-3-2	Class A	
Voltage fluctuations/ flicker emissions IEC61000-3-3	Complies	

Table 2 - Guidance and manufacturer's declaration - electromagnetic immunity -
for all EQUIPMENT and SYSTEMS (see 5.2.2.1f)

Guidance and manufacturer's declaration - electromagnetic immunity -			
The NAOMI is intended for use in the electromagnetic environment specified below. The customer or the user of the NAOMI should assure that it is used in such an environment.			
Immunity test	IEC 60601 test level	Compliance level	Electromagnetic environment - guidance
Electrostatic discharge (ESD) IEC61000-4-2	±6 kV contact ±8 kV air	±6 kV contact ±8 kV air	Floors should be wood, concrete or ceramic tile. If floors are covered with synthetic material, the relative humidity should be at least 30%
Electrical fast transient/burst IEC61000-4-4	±2 kV for power supply lines ±1 kV for input/output lines	±2 kV for power supply lines ±1 kV for input/output lines	Mains power quality should be that of a typical commercial or hospital environment.
Surge IEC61000-4-5	±1 kV line(s) to line(s) ±2 kV line(s) to earth	±1 kV line(s) to line(s) ±2 kV line(s) to earth	Mains power quality should be that of a typical commercial or hospital environment.
Voltage dips, short interruptions and voltage variations on power supply input lines IEC61000-4-11	<5% (>95% dip in U_T) for 0.5 cycle 40% U_T (60% dip in U_T) for 5 cycles 70% U_T (30% dip in U_T) for 25 cycles <5% U_T (>95% dip in U_T) for 5 sec	<5% (>95% dip in U_T) for 0.5 cycle 40% U_T (60% dip in U_T) for 5 cycles 70% U_T (30% dip in U_T) for 25 cycles <5% U_T (>95% dip in U_T) for 5 sec	Mains power quality should be that of a typical commercial or hospital environment. If the user of the NAOMI requires continued operation during power mains interruptions, it is recommended that the NAOMI be powered from an uninterruptible power supply or a battery.
Power frequency (50/60Hz)magnetic field IEC61000-4-8	3 A/m	3 A/m	Power frequency magnetic fields should be at levels characteristic of a typical location in a typical commercial or hospital environment.
NOTE U_T is the a.c. mains voltage prior to application of the test level.			

Table 4 - Guidance and manufacturer's declaration - electromagnetic immunity - for EQUIPMENT and SYSTEM that are not LIFE-SUPPORTING (see 5.2.2.2)



Guidance and manufacturer's declaration - electromagnetic immunity			
The NAOMI is intended for use in the electromagnetic environment specified below. The customer or the use of the NAOMI should assure that it is used in such an environment.			
Immunity test	IEC60601 test level	Compliance level	Electromagnetic environment - guidance
Conducted RF IEC61000-4-6	3 Vrms 150kHz to 80MHz	3 Vrms	Portable and mobile RF communications equipment should be used no closer to any part of the NAOMI, including cables, than the recommended separation distance calculated from the equation applicable to the frequency of the transmitter. Recommended separation distance $d = 1.2\sqrt{P}$ $d = 1.2\sqrt{P} \quad 80\sim 800\text{MHz}$ $d = 2.3\sqrt{P} \quad 800\text{MHz}\sim 2.5\text{GHz}$ where P is the maximum output power rating of the transmitter in watts [W] according to the transmitter manufacturer and is the recommended separation distance in meters [m]. Field strengths from fixed RF transmitters, as determined by an electromagnetic site survey, ^{a)} should be less than the compliance level in each frequency range. ^{b)} Interference may occur in the vicinity of equipment marked with the following symbol: <div style="text-align: right; margin-top: 10px;">  </div>
Radiated RF IEC61000-4-3	3 V/m 80MHz to 2.5GHz	3 V/m	
NOTE 1. At 80 MHz and 800MHz, the higher frequency range applies. NOTE 2. These guidelines may not apply in all situations. Electromagnetic propagation is affected by absorption and reflection from structures, objects and people.			
^{a)} Field strengths from fixed transmitters, such as base stations for radio (cellular/cordless) telephones and land mobile radios, amateur radio, AM and FM radio broadcast and TV broadcast cannot be predicted theoretically with accuracy. To assess the electromagnetic environment due to fixed RF transmitters, an electromagnetic site survey should be considered. If the measured field strength in the location in which the NAOMI is used exceeds the applicable RF compliance level above, the NAOMI should be observed to verify normal operation. If abnormal performance is observed, additional measures may be necessary, such as reorienting or relocating the NAOMI.			
^{b)} Over the frequency range 150 kHz to 80 MHz, field strengths should be less than 3 V/m.			

Table 6 - Recommended separation distances between portable and mobile RF communications equipment and the EQUIPMENT or SYSTEM - for EQUIPMENT and SYSTEM that are not LIFE-SUPPORTING (see 5.2.2.2)

Recommended separation distances between portable and mobile RF communications equipment and the NAOMI			
The NAOMI is intended for use in an electromagnetic environment in which radiated RF disturbances are controlled. The customer or the user of the NAOMI can help prevent electromagnetic interference by maintaining a minimum distance between portable and mobile RF communications equipment (transmitters) and the NAOMI as recommended below, according to the maximum output power of the communications equipment.			
Rated maximum output power of transmitter W	Separation distance according to frequency of transmitter m		
	150kHz~80MHz $d = 1.2\sqrt{P}$	80~800MHz $d = 1.2\sqrt{P}$	800MHz~2.5GHz $d = 1.2\sqrt{P}$
0.01	0.12	0.12	0.23
0.1	0.38	0.38	0.73
1	1.2	1.2	2.3
10	3.8	3.8	7.3
100	12	12	23
For transmitters rated at a maximum output power not listed above, the recommended separation distance in meters [m] can be estimated using the equation applicable to the frequency of the transmitter, where P is the maximum output power rating of the transmitter in watts [W] according to the transmitter manufacturer.			
NOTE 1. At 80 MHz and 800MHz, the separation distance for the higher frequency range applies.			
NOTE 2. These guidelines may not apply in all situations. Electromagnetic propagation is affected by absorption and reflection from structures, objects and people.			

Specifications / Performance

Product Name	Multi CCD Digital Radiography NAOMI-2001	Multi CCD Digital Radiography NAOMI-2002	Multi CCD Digital Radiography NAOMI-2004	Multi CCD Digital Radiography NAOMI-2006
Sensor Structure	CCD (Charge Coupled Devices)			
Method	Scintillator			
Maximum Active Area	435×432mm (17.1"×17")	348×432mm (13.7"×17")	261×324mm (10.2"×12.7")	261×216mm (10.2"×8.5")
Pixel Resolution	7680×7872 (60.46Mega Pixels)	6144×7872 (48.37Mega Pixels)	4608×5904 (27.21Mega Pixels)	4608×3936 (18.14Mega Pixels)
Power Consumption	AC Adapter, DC12V/8.33A			
Amperage Rating	DC12V			
Amperage Rating	5A	4A	2.3A	1.6A
Amperage Rating	AC100V - 240V, 50 - 60Hz			
Environmental conditions for Operation	An ambient temperature: 15 °C to 35 °C (59°F to 95°F) An ambient humidity: 30% to 70% (without condensation) Atmospheric pressure: 75kPa to 106kPa (750mB to 1060mB)			
Protection class against electric shock	Class I			
Protection degree against electric shock	Type BF Applied Parts 	Operation Mode: Continuous Operation		
Protection degree of externals against water	IPX0			
Maximum X-ray Attenuation Equivalent of irradiated surface (Carbon Plate)	0.16±0.01mAl			
Data Output	DICOM / BMP / JPEG / PNG / GIF			
CCD Camera	Type	1/3"CCD (RJ2314CB0PB) Ceramic DIP package (Manufactured by SHARP)		
	CCD Pixel Pitch	Horizontal 7.2µm x Vertical 5.6µm		
	Lens	Fixed Focus Lens Focal Length 3.27mm F Value 1.8		
Scintillator	Type	General Medical Device Appliances 84 Scintillator for Radiography System		
	Luminance	93		
	MTF	185		
	Protective Film	PET6µm		
	Fluorescent Film	140µm、68mg / cm ²		
	Support	250µm		
	Total Thickness	406µm		
Environmental conditions for transport and storage	An ambient temperature: -5 °C to 50 °C (23°F to 122°F) An ambient humidity: 20% to 80% (without condensation or frost) Atmospheric pressure: 75kPa to 106kPa			
Service Life	5 Years (Operated in accordance with the precaution for safe use.)			
Dimension: W x D x H	482mm×551mm×60mm	395mm×551mm×60mm	306mm×449mm×60mm	306mm×330mm×60mm
Weight	9.0kg	7.6kg	5.2kg	3.9kg

Appearance / Dimensions

NAOMI-2001

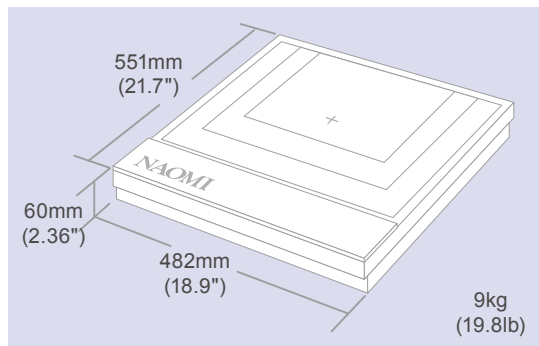

NAOMI-2002

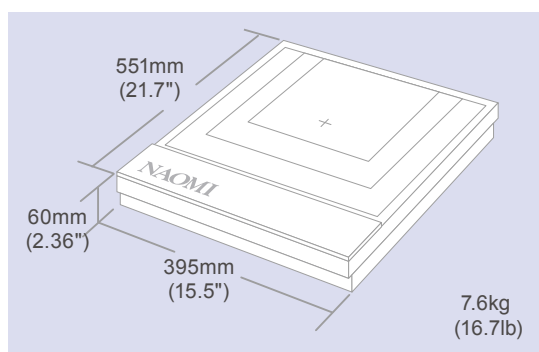

NAOMI-2004

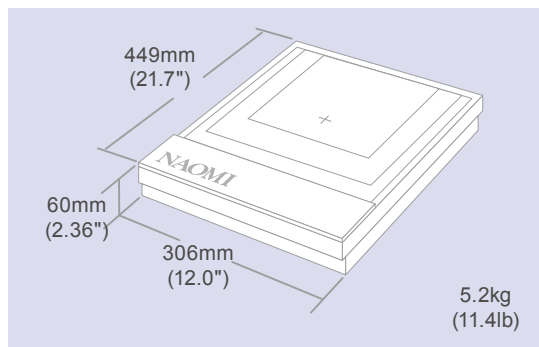

NAOMI-2006

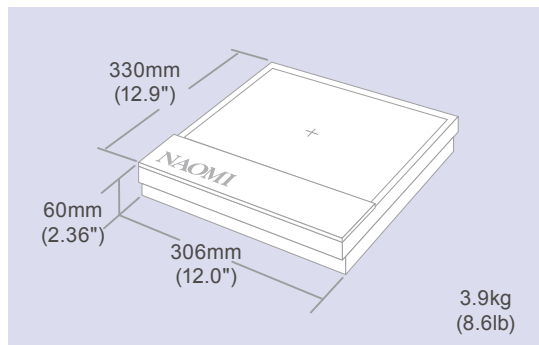

Packaged Items

NOTE ! Please make sure the following items are included in the package. If any items are missing, please contact us.



Sensor (x1)

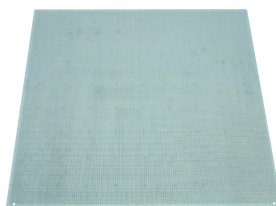

Calibration Scale (x1)



AC Adapter (x1)
*with On/Off switch



Power Cable (x1)



USB Cable (4m) (x1)



NAOMI System CD-ROM (x1)

Features

● Main Unit

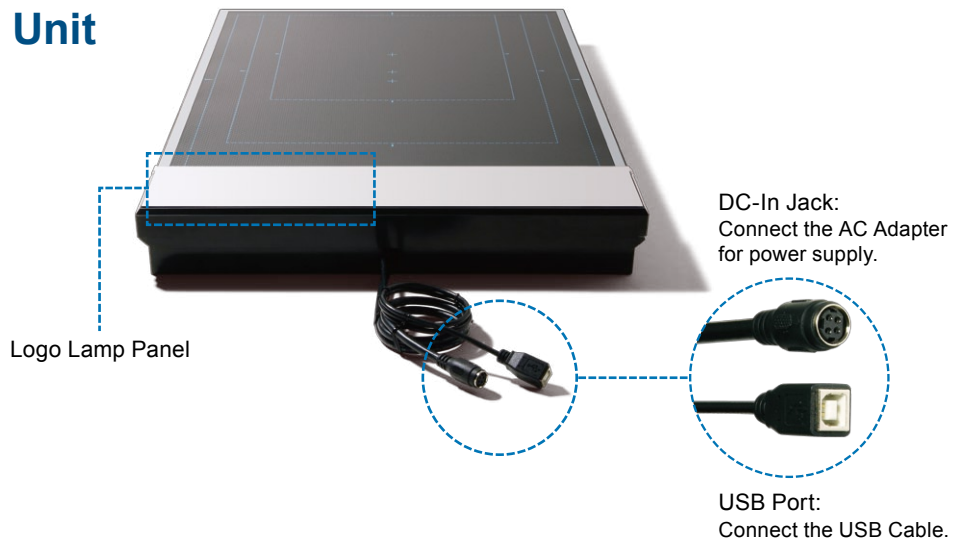

● Area Target for Irradiation (NAOMI-2001)

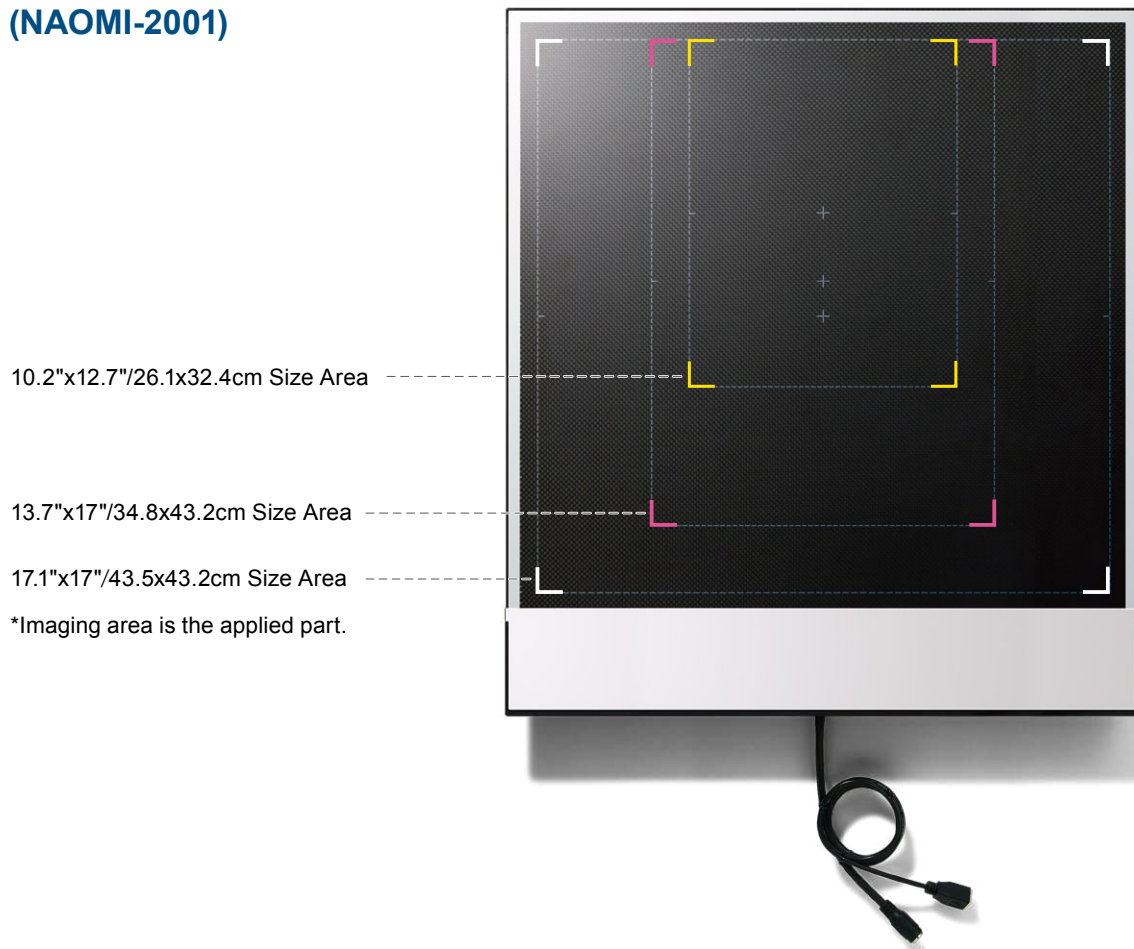

Set up the NAOMI Sensor

Place the sensor.

Plug in AC Adapter, Power Cable, and connect USB Cable.

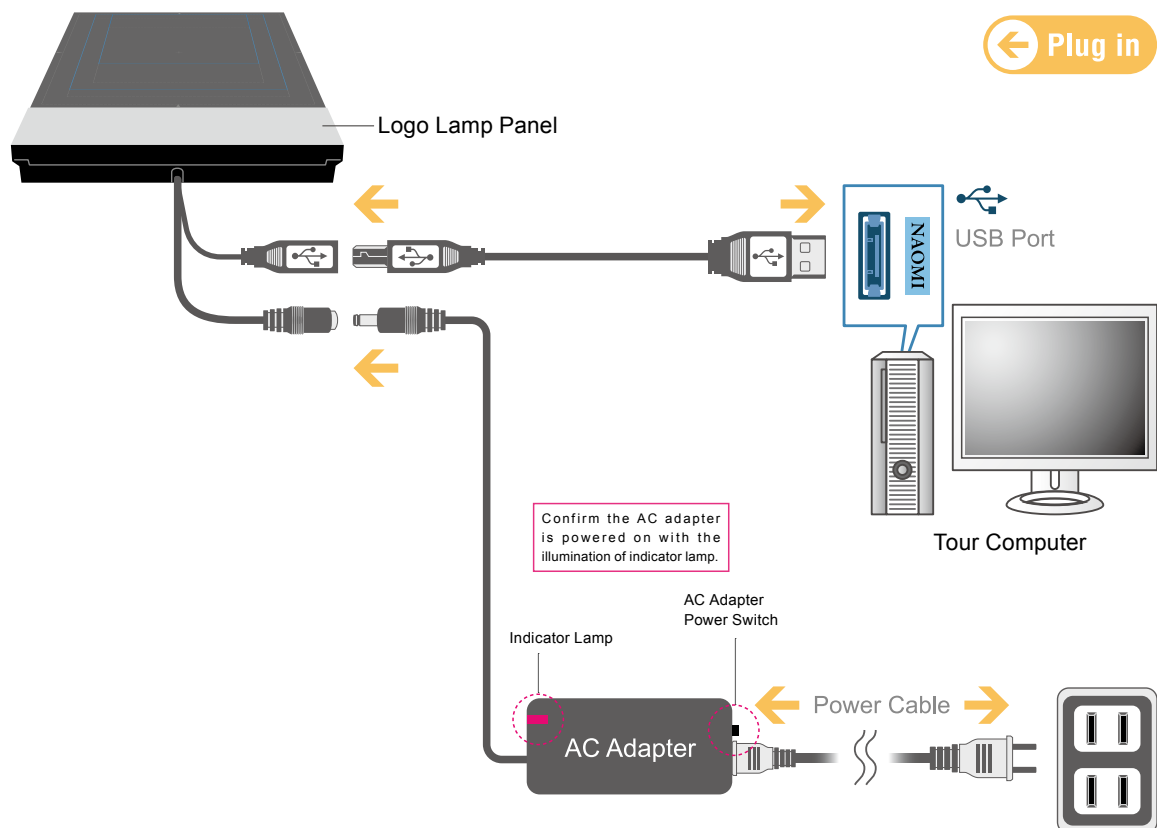

CHECK THE LOGO LAMP PANEL ON THE MAIN UNIT.
They indicate proper cable connections.



When you connect the cables properly and turn on the computer, Logo Lamp Panel on the main unit lights up.



If Logo Lamp Panel does not light up even after the computer turns on, the cables are not connected properly. Unplug the cables, and retry the cables to be connected properly.



NOTE

If the NAOMI driver and/or software are not installed in your computer, refer to the Installation Section (Installation- 03-10, for Driver Installation ; Installation-11-21, for Software Installation).



NOTE

Refer to the upright stand (or upright stand bracket) installation guide for the upright position setting.



CAUTION

Make sure to turn off the photo timer, electricity bucky equipment, or any other equipment close to the NAOMI unit. The strong magnetic field may cause the malfunctioning on the image capturing process.

Installation

Follow the next three steps to install the NAOMI Driver and Imaging Software.

STEP
1 *Install the NAOMI Driver*
(Page : Installation 03-10)



STEP
2 *Install the NAOMI Imaging Software*
(Page : Installation 11-15)



STEP
3 *Copy the NAOMI Imaging Data*
(Page : Installation 16-21)

1 Install the NAOMI Driver



NOTE

Prior to use the NAOMI sensor, [the NAOMI driver must be installed](#) to your computer. Without installing the driver information to your computer, the NAOMI sensor will not work properly.



NOTE

RF has installed the driver already if you purchase a computer together with NAOMI. In such case, you do not need to install the driver. Connect the USB cable to the USB port with the “NAOMI” sticker on the back of the computer.



CHECK!!

Confirm the NAOMI system is properly connected.

Follow the instruction below to set up the sensor to your computer.

(Refer to the “Set up the NAOMI Sensor” page for more details on the setup process.)

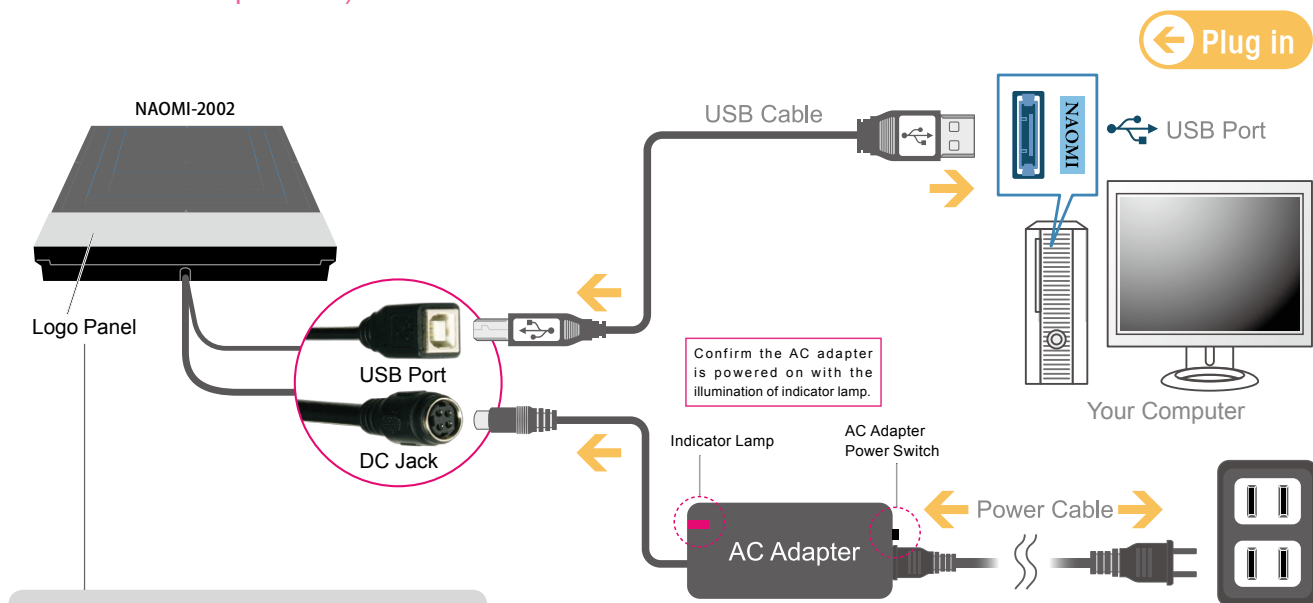

Check the logos light up.

This indicates the cable connections and the computer is on. If not connected or if the computer is off, the logo doesn't light up.



1. Place the NAOMI sensor on to the upright stand or x-ray table.
2. Connect the AC adapter to the power outlet and to the NAOMI sensor.
3. Connect the USB cable to the NAOMI sensor and to your computer.



4 LEDs light up to indicate the condition of the NAOMI unit.

- Green: Power cable is connected properly.
- Light Blue: The sensor unit power is on.
- White: USB cable is connected properly.
- Green: Stand-By, and ready to detect the x-ray
- Dark Blue: Capture completes.

Windows XP

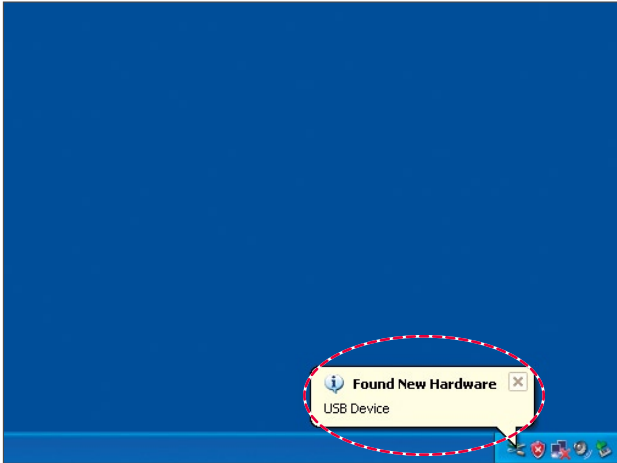

1. After connecting the USB cable to the NAOMI sensor and the computer's USB port, the message, "Found New Hardware USB Device", appears on the right bottom corner of the computer monitor. Click on the message to start the installation process.

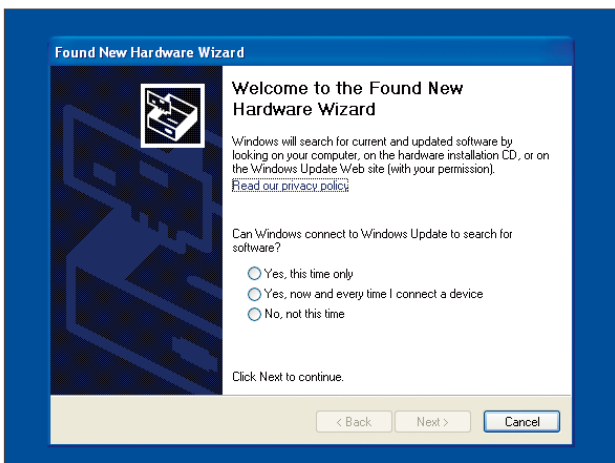

2. After a few seconds, "Found New Hardware Wizard" appears. Insert [NAOMI System CD-ROM](#) to the CD-ROM drive of the computer.

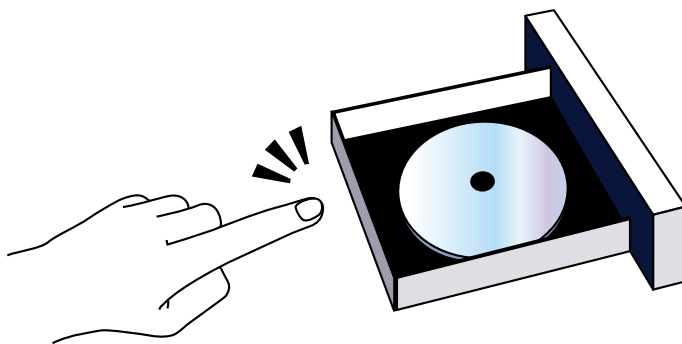

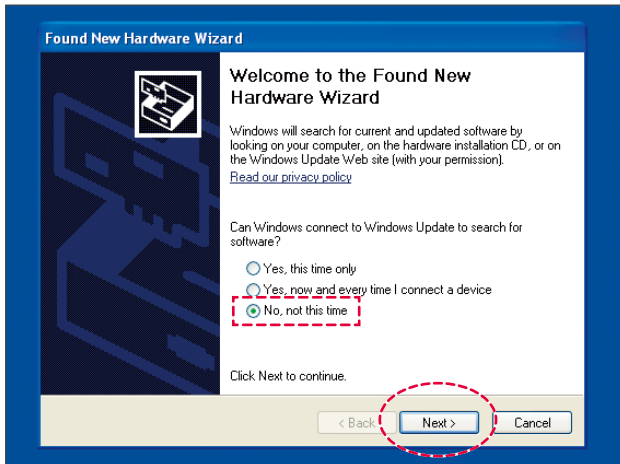

3. The wizard asks “Can windows connect to windows update to search for software?”.

Select “No, not this time” and click

Next >

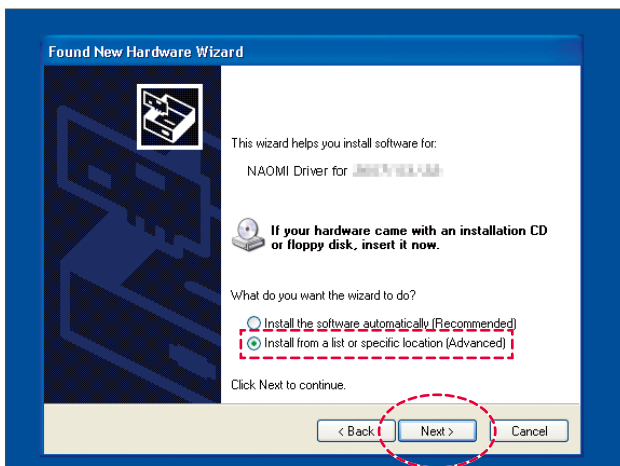

4. Select “Install from a list or specific location [Advanced]” and click **Next >**.

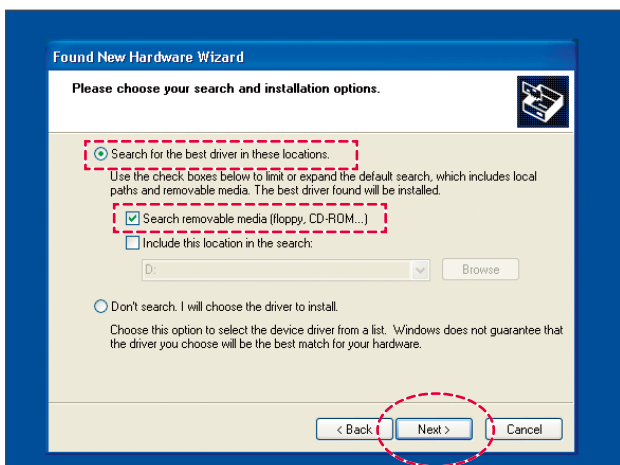

5. Select “Search for the best driver in these locations.”

Check “Search removable media,” and click **Next >**.

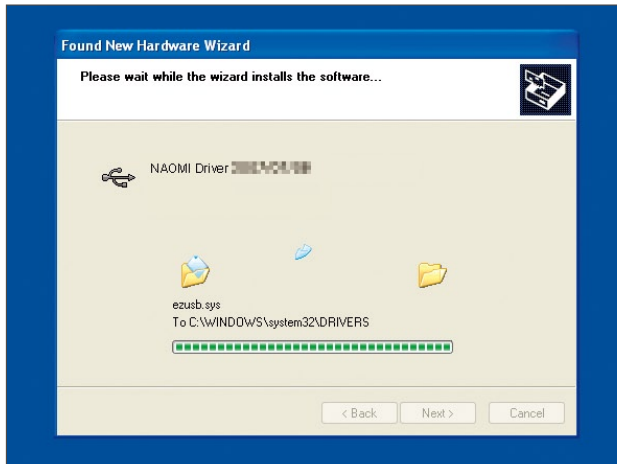

6. The wizard automatically starts the installation process of the NAOMI driver.

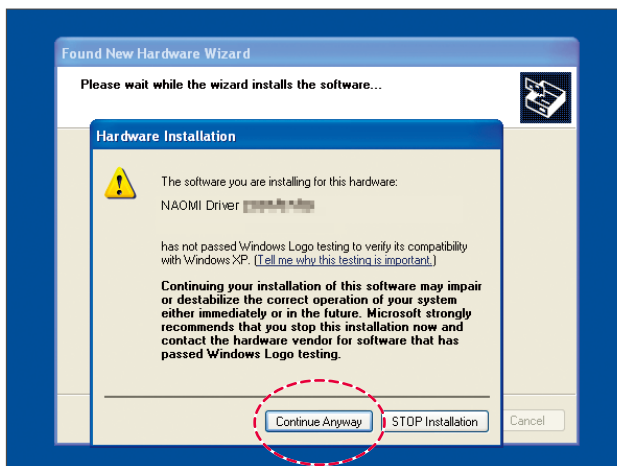

7. If the Hardware Installation window is displayed, click .

The installation process continues.

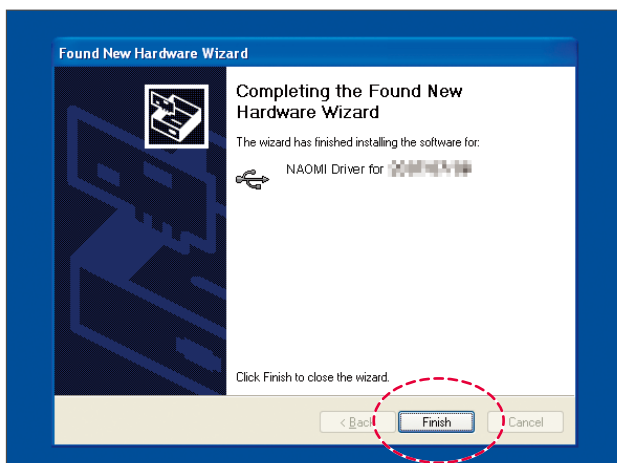

8. The NAOMI driver installation is completed.

Click .



9. After a few seconds, the message, "Found New Hardware. Your new hardware is installed and ready to use." appears on the right bottom of the computer monitor.

The NAOMI driver is successfully installed.

***The driver installation process for Windows XP is completed.
Proceed to Install the NAOMI Imaging Software (Installation - 11).***

Windows Vista / Windows 7

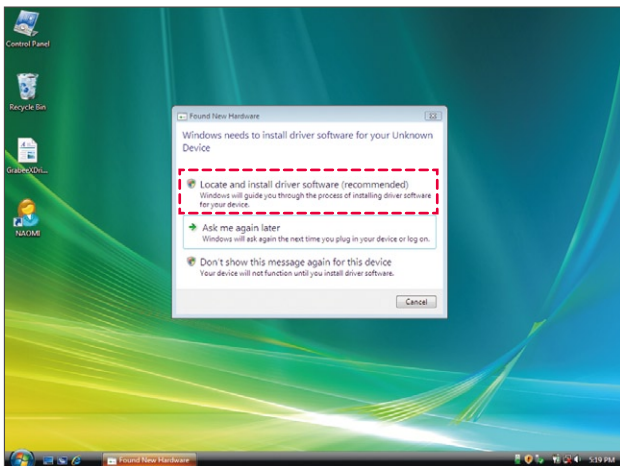

1. After connecting the USB cable to the NAOMI sensor and the computer's USB port, the menu, "Found New Hardware," shows up on the middle of the desktop menu.

Click "Locate and install driver software (recommended)" to start the installation process.

NOTE

If the window "Found New Hardware" does not appear on the desktop, minimize other windows. Or, click "Found New Hardware" on the task bar.

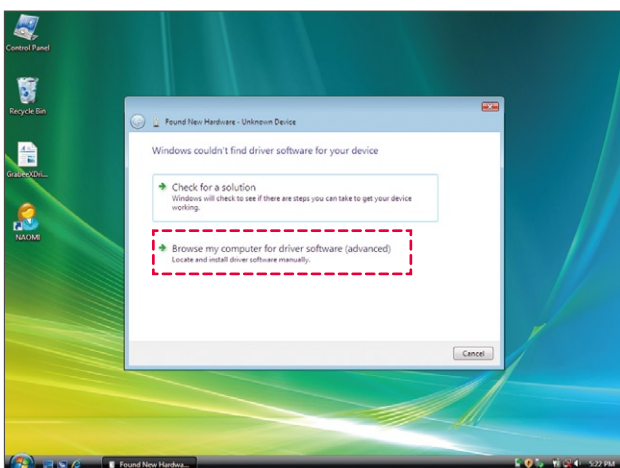

2. Click "Browse my computer for driver software (advanced)".

3. Insert [NAOMI System CD-ROM](#) to the CD-ROM drive of the computer.

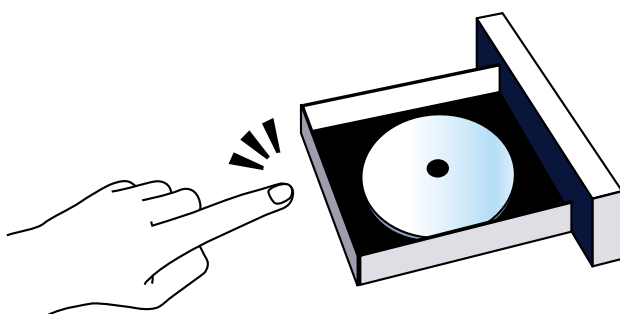

Install the NAOMI Driver (Vista / Windows 7)

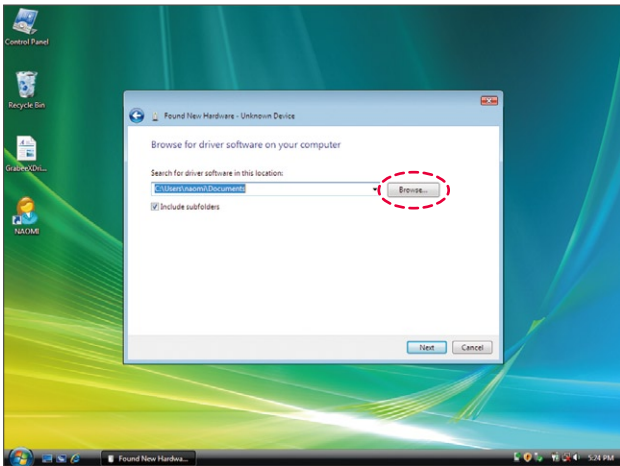

4. In order to locate the driver software, click “Browse...”

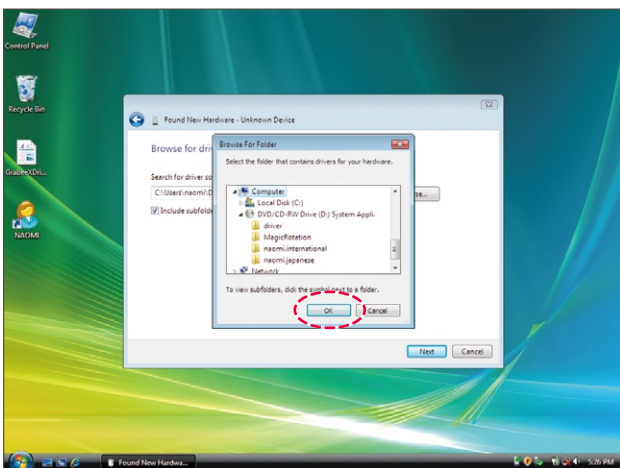

5. “Browse For Folder” menu shows up. Click “>” next to “Computer”, click “>” next to “DVD/CD-RW Drive (D:)” and select “driver” folder. Then, click

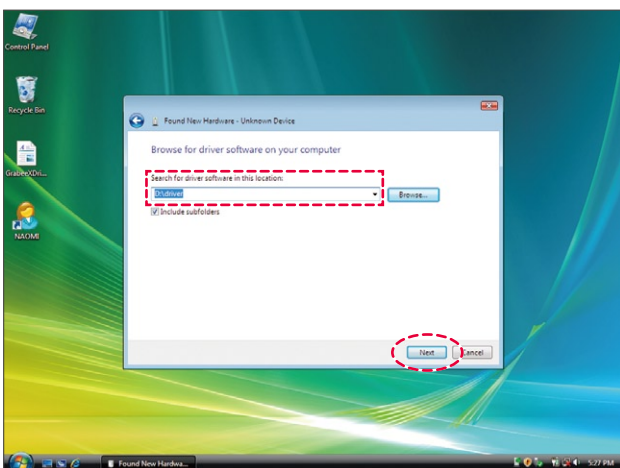
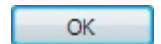

6. Make sure that the search location is set as “D:/driver”. Click

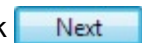

Install the NAOMI Driver (Vista / Windows 7)

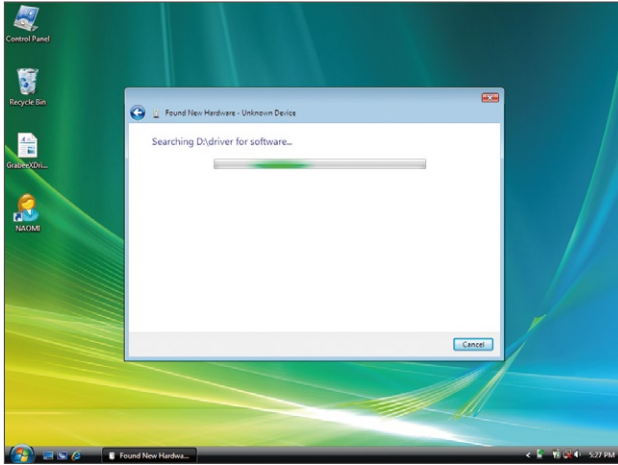

7. Wait for the computer to search the driver software.

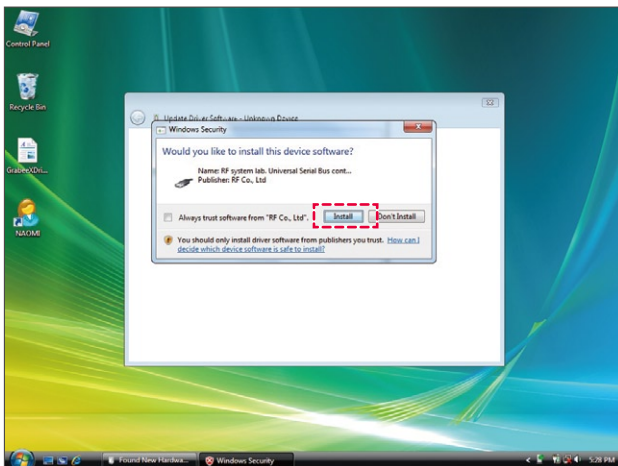

8. When the Windows Security menu shows up, click “Install this driver software anyway”.

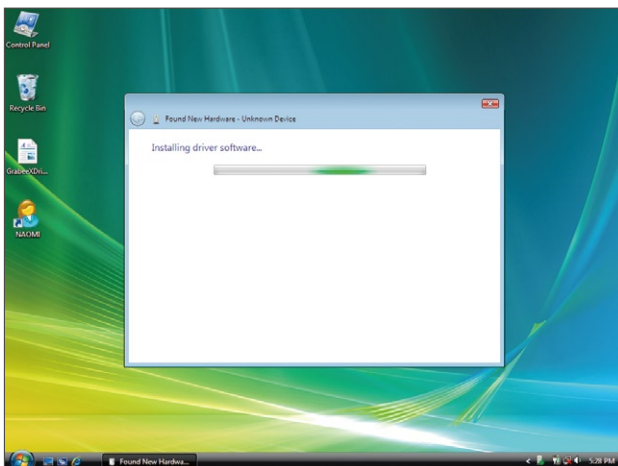

9. The installation process continues.

Install the NAOMI Driver (Vista / Windows 7)

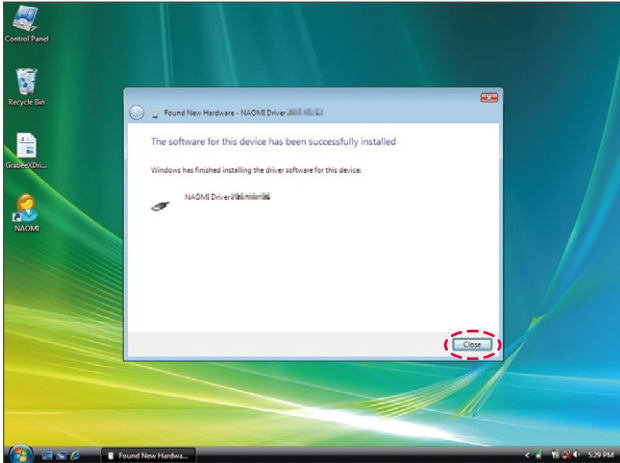

10. The NAOMI driver installation is completed.

Click .

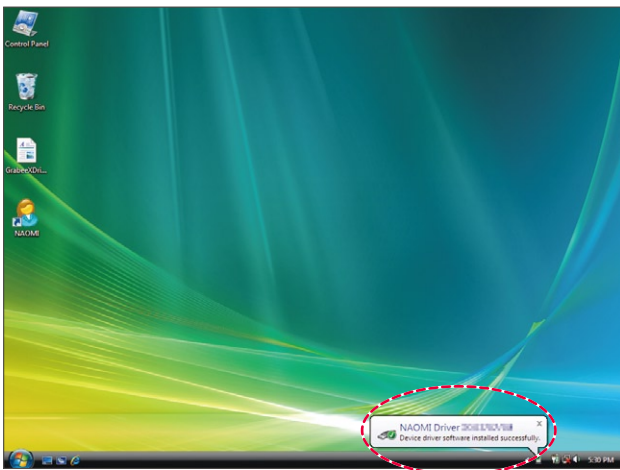

11. After a few seconds, the message, “Device driver software installed successfully” appears on the right bottom of the computer screen.

The NAOMI driver has been installed successfully.

The installation process for Windows Vista/Windows 7 is completed. Proceed to Install the NAOMI Imaging Software (Installation - 11).

Install the NAOMI Imaging Software

**NOTE**

This process is to install the NAOMI software into a computer for the first time.

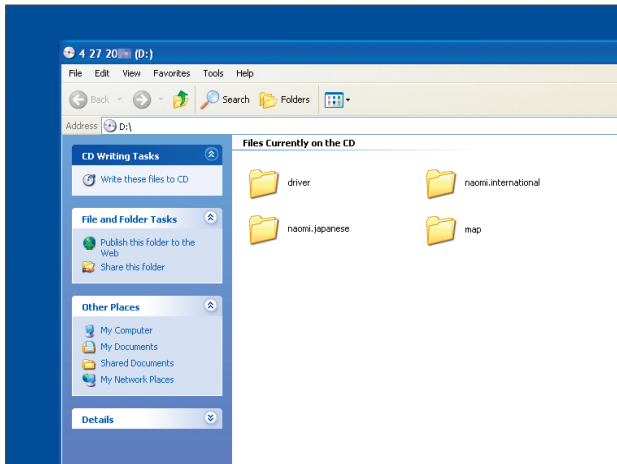

1. Insert **NAOMI System CD-ROM** into the CD-ROM drive on your computer. After a few seconds, the CD-ROM window will automatically appear.

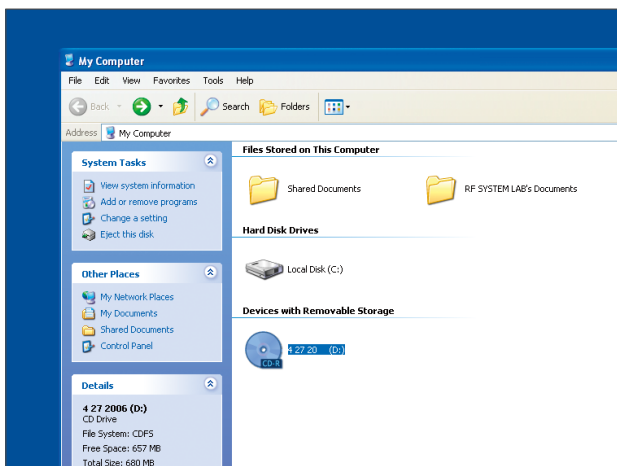

If the above window does not appear automatically, double click the CD-ROM drive from My Computer.

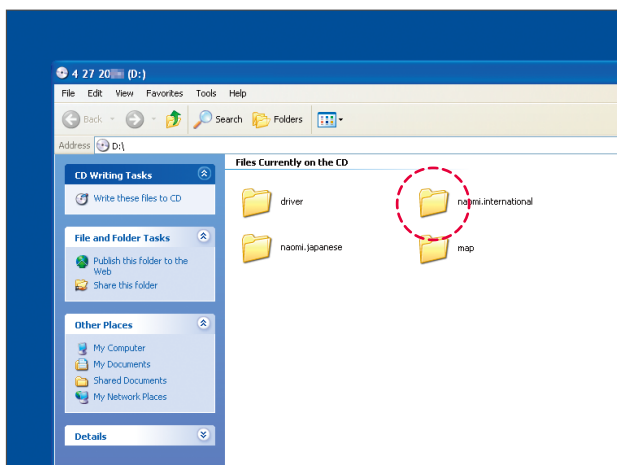

2. Double click the **naomi.international** folder to open.

Install the NAOMI Imaging Software

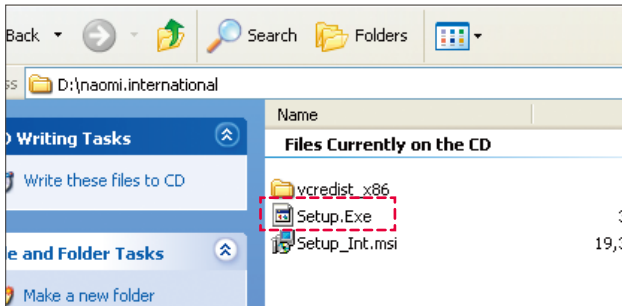

3. Double click **Setup.exe** to start the installation process.

NOTE Windows Vista

When double-clicking on “Setup.exe” on a computer with Windows Vista, “User Account Control” wizard may show up, stating “An unidentified program wants access to your computer.” Click “Allow: I trust this program. I know where it’s from or I’ve used it before” to start the installation.

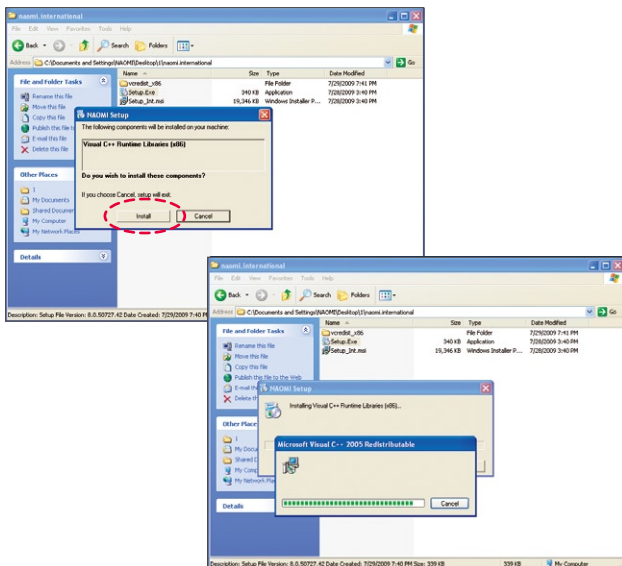

4. The window NAOMI Setup (Runtime Library) automatically opens. Click **“Install”** to start the installation process.



When the Runtime Library window does not automatically open up and the NAOMI Setup Wizard opens as shown in the next step (Step. 5), follow the manual and complete the installation process of the NAOMI Setup Wizard. After the wizard confirms the installation, go to the page [Installation - 14](#) to complete the installation of the Runtime Library.

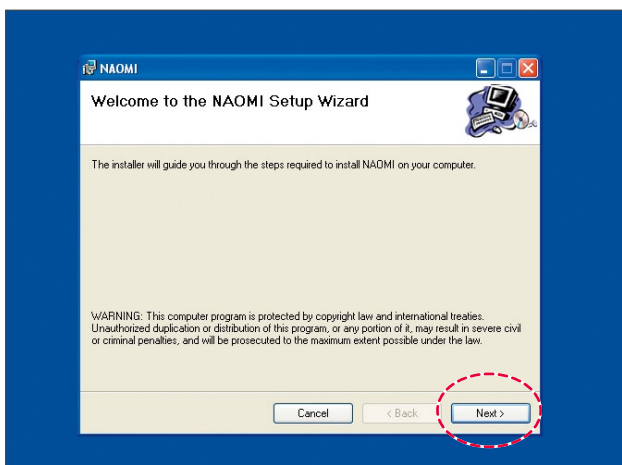

5. NAOMI Setup Wizard automatically opens. The wizard will guide you through the steps to install NAOMI on your computer.

Click .

Install the NAOMI Imaging Software

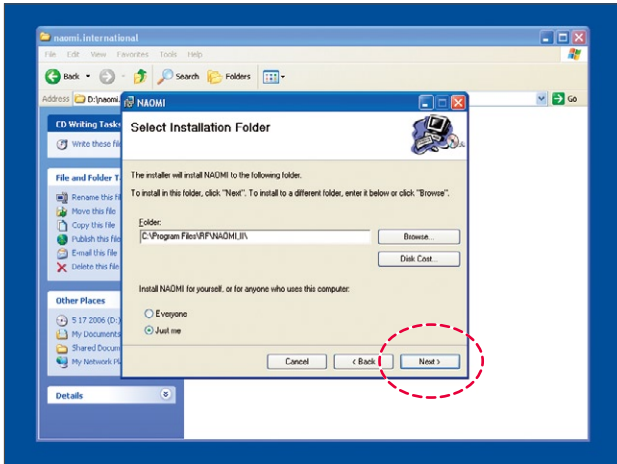

- Click unless you need to change the folder to install NAOMI.

NOTE

This manual shows you how to install NAOMI to C:/Program Files/RF/NAOMI_II (default setting).

NOTE

Record the location that NAOMI is installed in this process. You may need to access the location later.

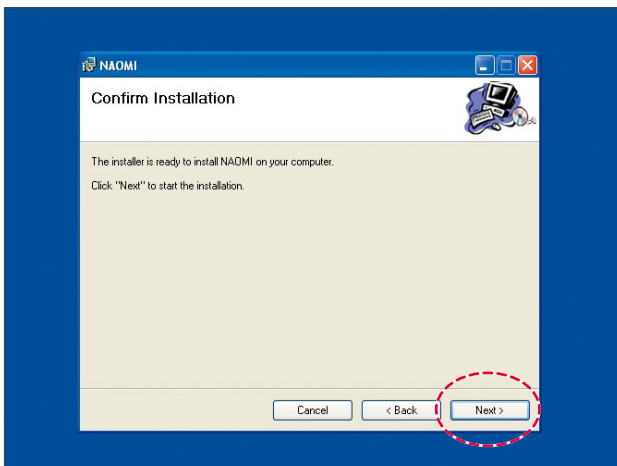

- Click to start the installation.

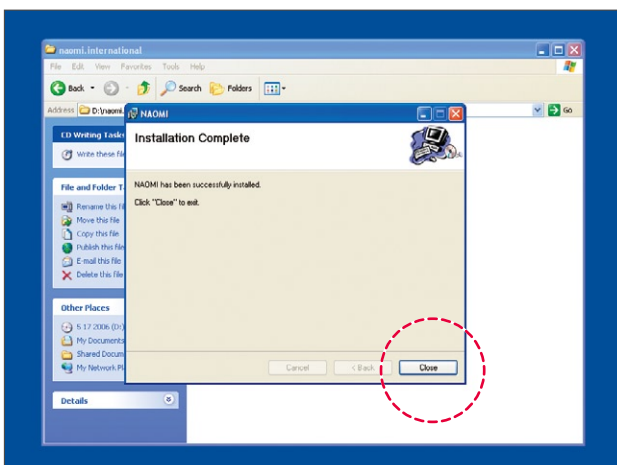

- Wait until the NAOMI software installation is completed.

NOTE

It may take few minutes to complete.

“Installation Complete” appears, after the NAOMI Software has been installed to your computer successfully.

Click to exit.

The NAOMI icon will be displayed on the desktop.





In the following cases, the NAOMI software is not completely installed.

- NAOMI Setup window does not open and the NAOMI Setup wizard starts when double-clicking on “Setup.exe” in the installation step 3, Page Installation - 03.
- The error message (Page Software - 01) opens when double-clicking on the NAOMI icon on the desktop and the NAOMI software does not start.

Follow the process below to completely install the NAOMI software (Runtime Library).

Runtime Library Installation

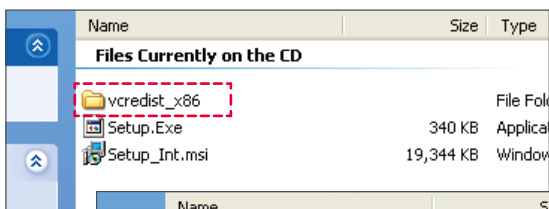

Double click on the **“vcredist_x86”** folder under NAOMI Software CD-ROM, and double click on **vcredist_x86** to start the installation process for Runtime Library.

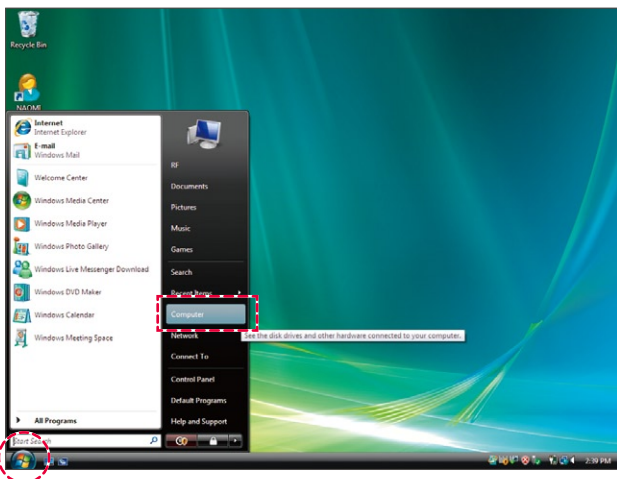
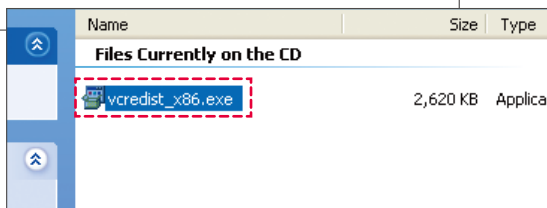

Privilege level on Windows Vista / Windows 7

In order to set the correct compatibility for NAOMI software to operate in Windows Vista and Windows 7, the privilege level must be set up with the following instructions.

Click “Start”, then select “Computer”.

Install the NAOMI Imaging Software

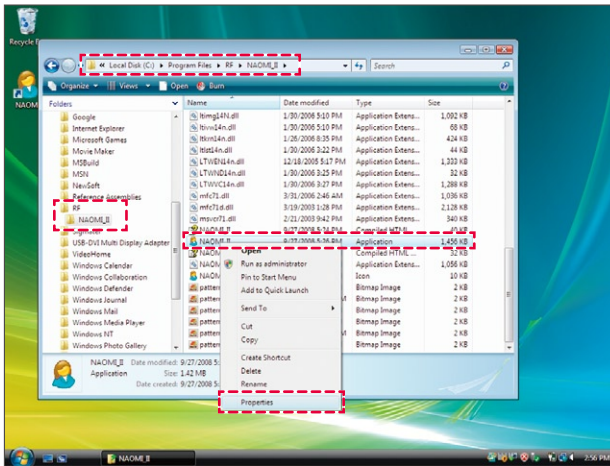

1. Double-click on Local Disk (C:), then Program Files. Double-click on RF folder, then NAOMI_II folder. Inside of NAOMI_II folder, right click on **NAOMI_II.exe** file and then select “Properties”.

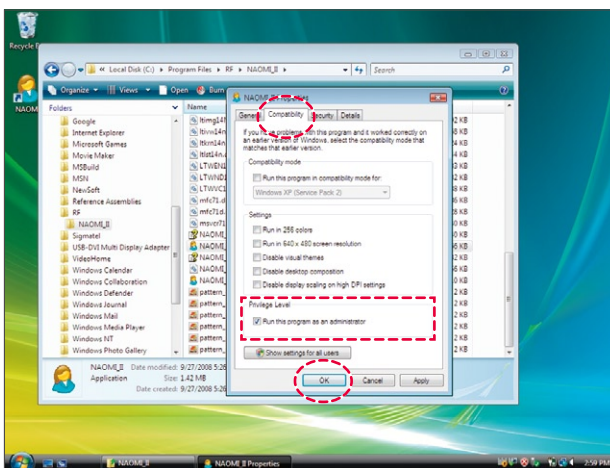

2. Click “Compatibility” tab on NAOMI_II properties window. Check on “Run this program as an administrator” under Privilege Level.

Click “OK”.

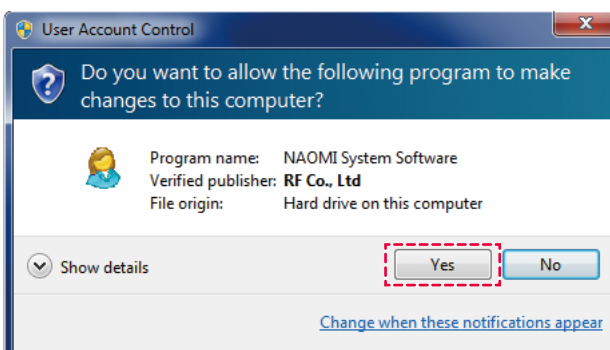

3. When you open the NAOMI software in the next time, the windows ask to either allow or cancel accessing the software.

Click “Yes” (or “Allow”).

3 Copy the NAOMI Imaging Data

Follow this instruction to copy the imaging data when RF customer support instructs to do so, or the NAOMI software is installed on a computer for the first time.

In this process, you are to copy [the NAOMI imaging data to your computer](#). The imaging data controls the proper image capturing on the NAOMI sensor.

Prior to use the NAOMI sensor, the NAOMI imaging data must be copied to your computer. The NAOMI sensor cannot capture digital images properly without copying the imaging data.

**NOTE**

If you change the software location in the installation process, open the NAOMI folder and follow the process from #6.

**NOTE**

It is not necessary to copy the imaging data when the NAOMI software is re-installed, as the data remains stored in the map folder.

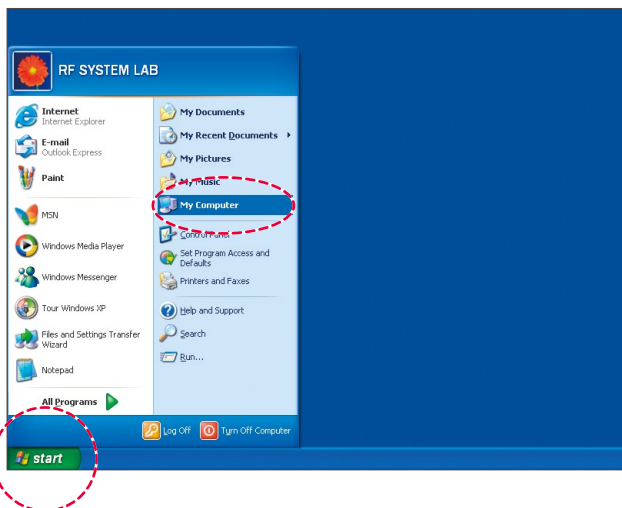

1. Click Start and go to My Computer.

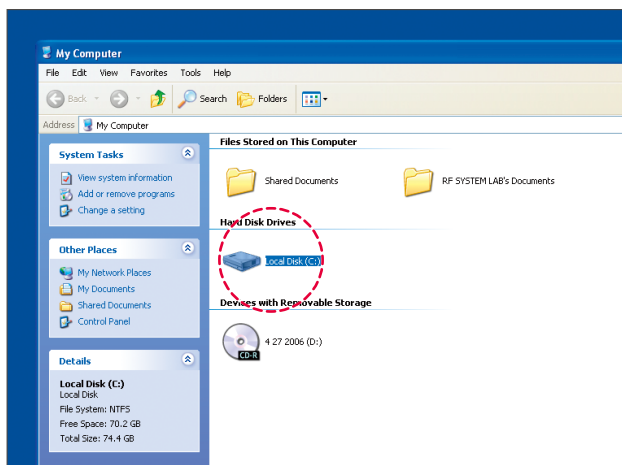

2. Double click Local Disk (C:) on My Computer.

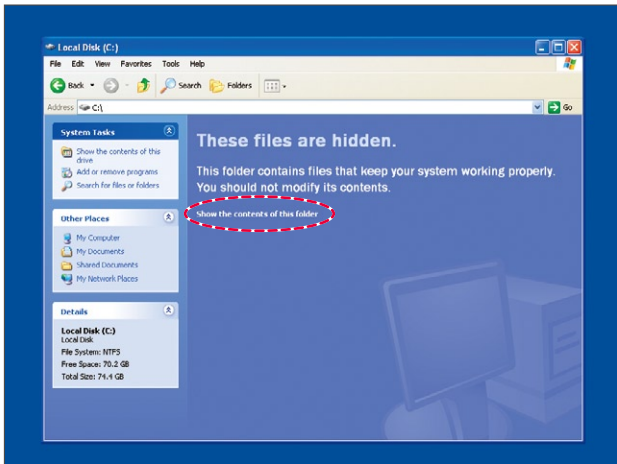

The window may show "These files are hidden."

Click "Show the contents of this folder".

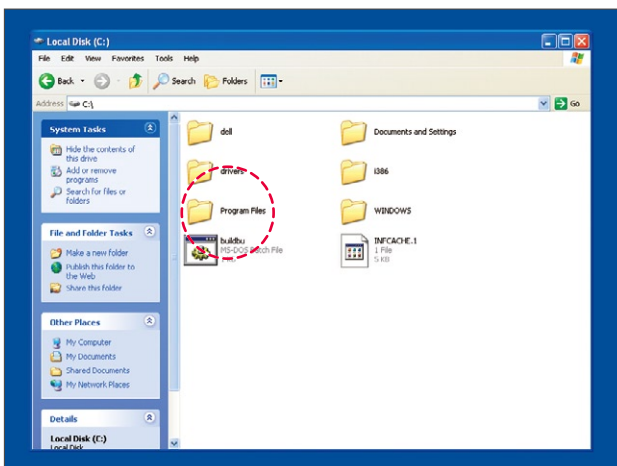

3. Double click Program Files to open.

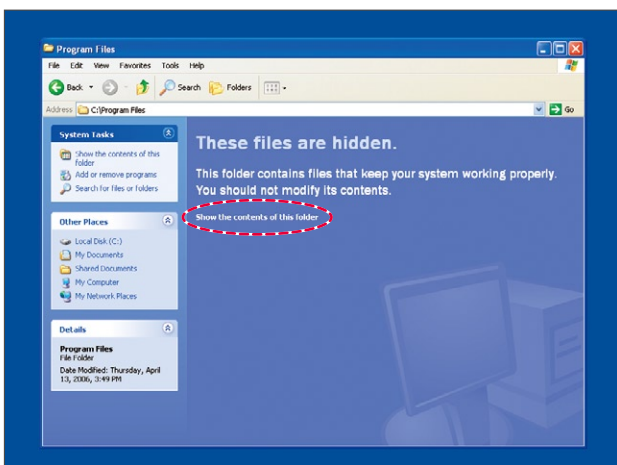

The window may show "These files are hidden."

Click "Show the contents of this folder".

Copy the NAOMI Imaging Data

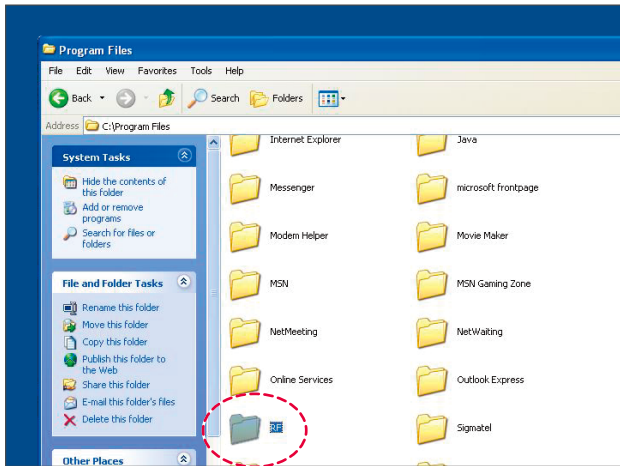

4. Double click the RF folder to open.

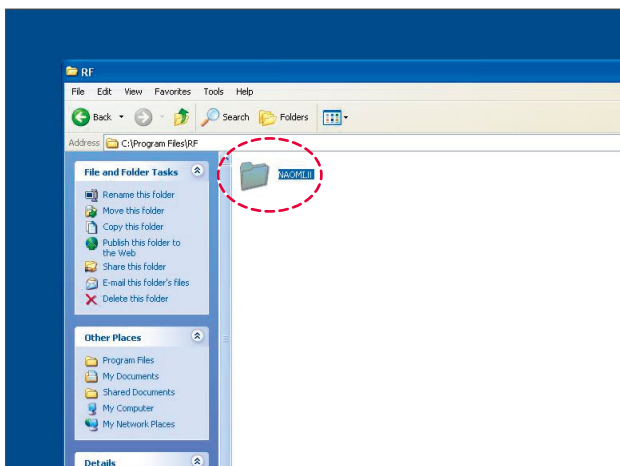

5. Double click the NAOMI folder (or NAOMI_II folder) to open.

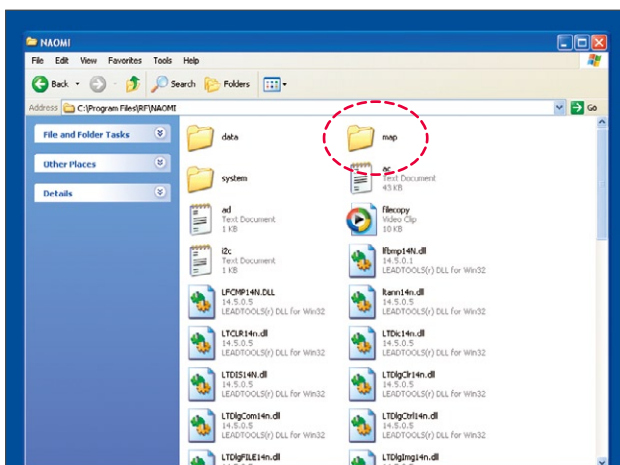

6. Double click the map folder to open.

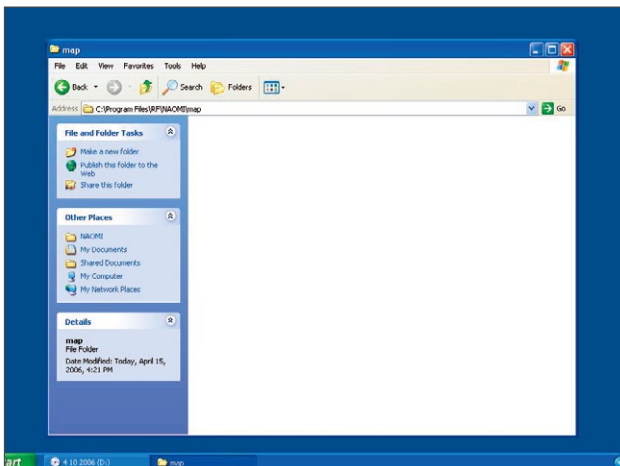

If there are any files in this folder, delete all files.

The map folder must not contain any files before proceeding to the next step if you are to use NAOMI with your computer for the first time. This is where the new files are copied to in the next step.

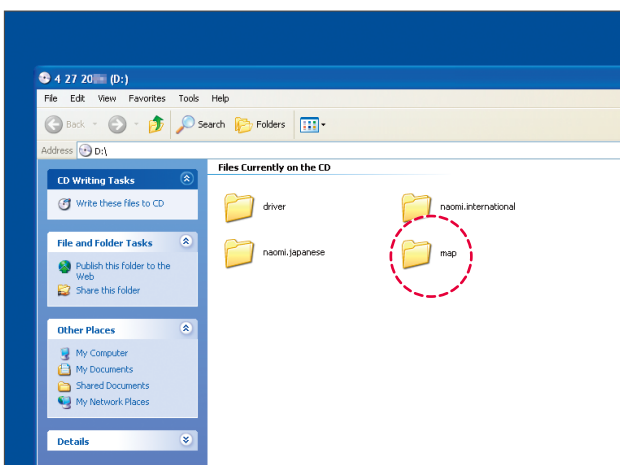

7. Insert **NAOMI System CD-ROM**, which come with the sensor you are currently trying to set up with, into your computer's CD-ROM drive. The window automatically appears in a few seconds. Then, open map folder. You will find the three files.

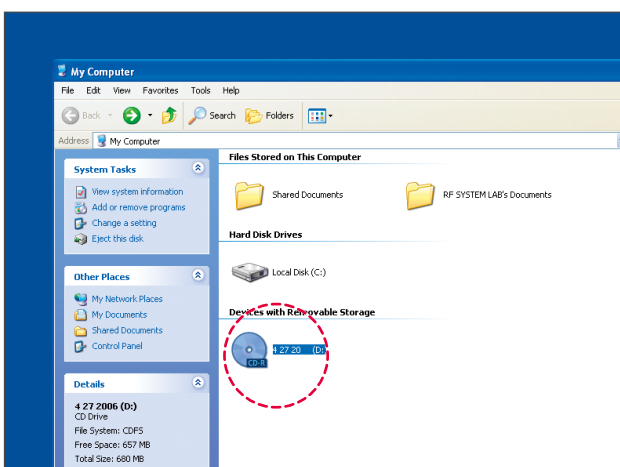

If the above window does not appear automatically, double click the CD-ROM drive on My Computer.

Copy the NAOMI Imaging Data

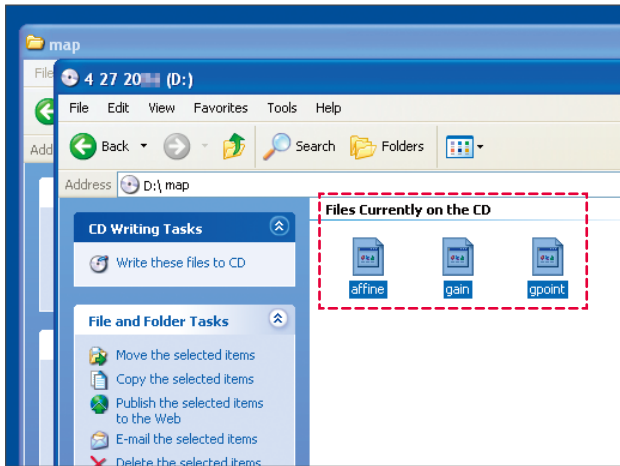

8. There are three files in the map folder in the CD-ROM. Use the mouse to [select all three files](#).

NOTE

All three files must be selected.

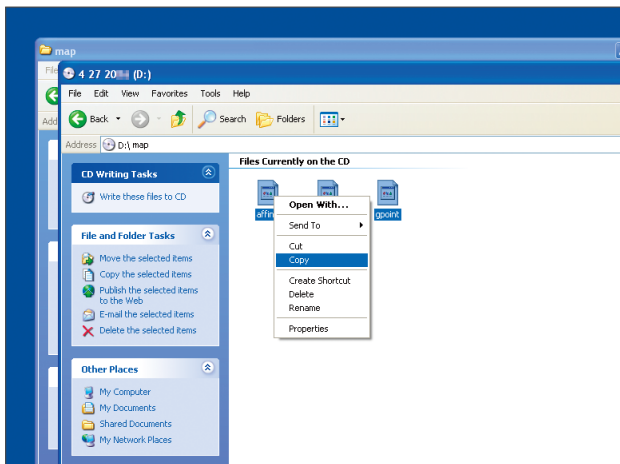

9. Copy all three files.
(Or, you may copy the files by right-clicking on the mouse and select “Copy”.)

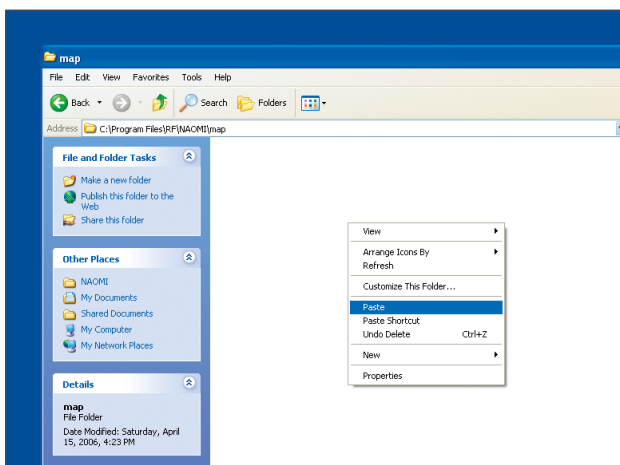

10. Paste three files on the map folder ([C:\Program Files\RF\NAOMI\map](#)).
(Or, you may paste the files by right-clicking on the mouse and select “Paste”. Or click and drag the files into the map folder.)

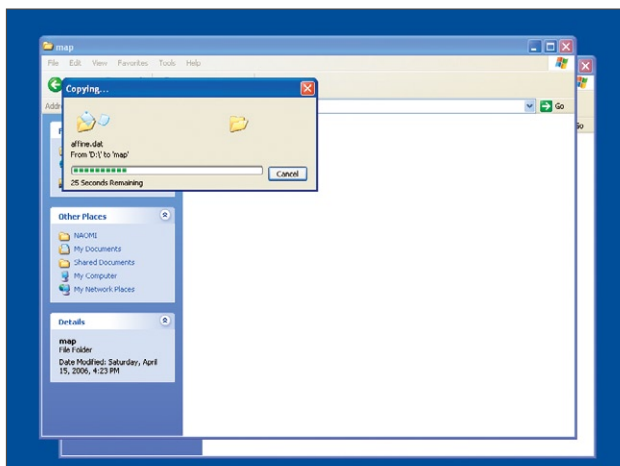

11. It starts copying the data.

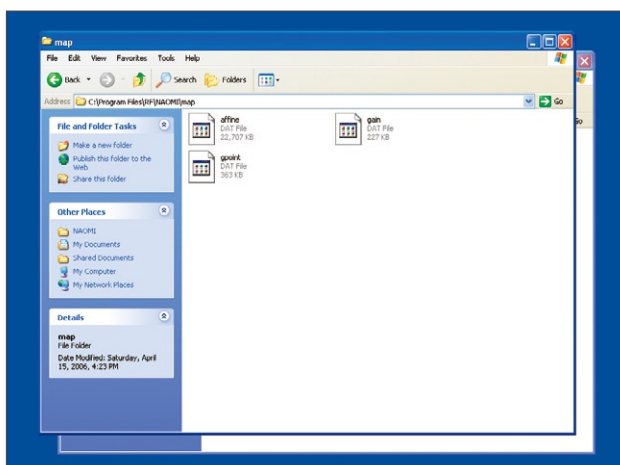

12. After the copying process is completed, confirm there are three files in the map folder.

NOTE

Right click on each copied file and select properties. Confirm the “Read-only” checkbox is unchecked. If the copied files are set as “Read-only”, the calibration / QAP data cannot be updated. Thus, it causes the NAOMI software to shut down when the calibration process is executed. These files need to be set as NOT “Read-only” files. (For calibration / QAP, refer to the QAP (Quality Assurance Program) section.)

Close “map” window to finish.

NOTE

If the NAOMI system or software does not work or an image does not appear after capturing, please go through this chapter again. Make sure you have followed every step properly on the installation process. If the problem remains unsolved, contact RF Technical Support.

***Copying the NAOMI imaging data has been finished.
The installation has been completed.***

Operation Check

Before you start using the NAOMI system, follow the instruction in this chapter to check the sensor for its functionality.

Prior to the shipment, the system has been tested and calibrated for both positioning and luminance for immediate use upon its arrival. However, in rare cases, calibration (QAP (Quality Assurance Program)) may be required to be processed. (Calibration is the process to correct misalignment and contrast unevenness on each CCD sensor in NAOMI. Refer to Calibration (QAP (Quality Assurance Program)) section for details.)

If there is a problem during the operation, refer to Troubleshooting Guide section or contact RF Technical Support.

This section includes...

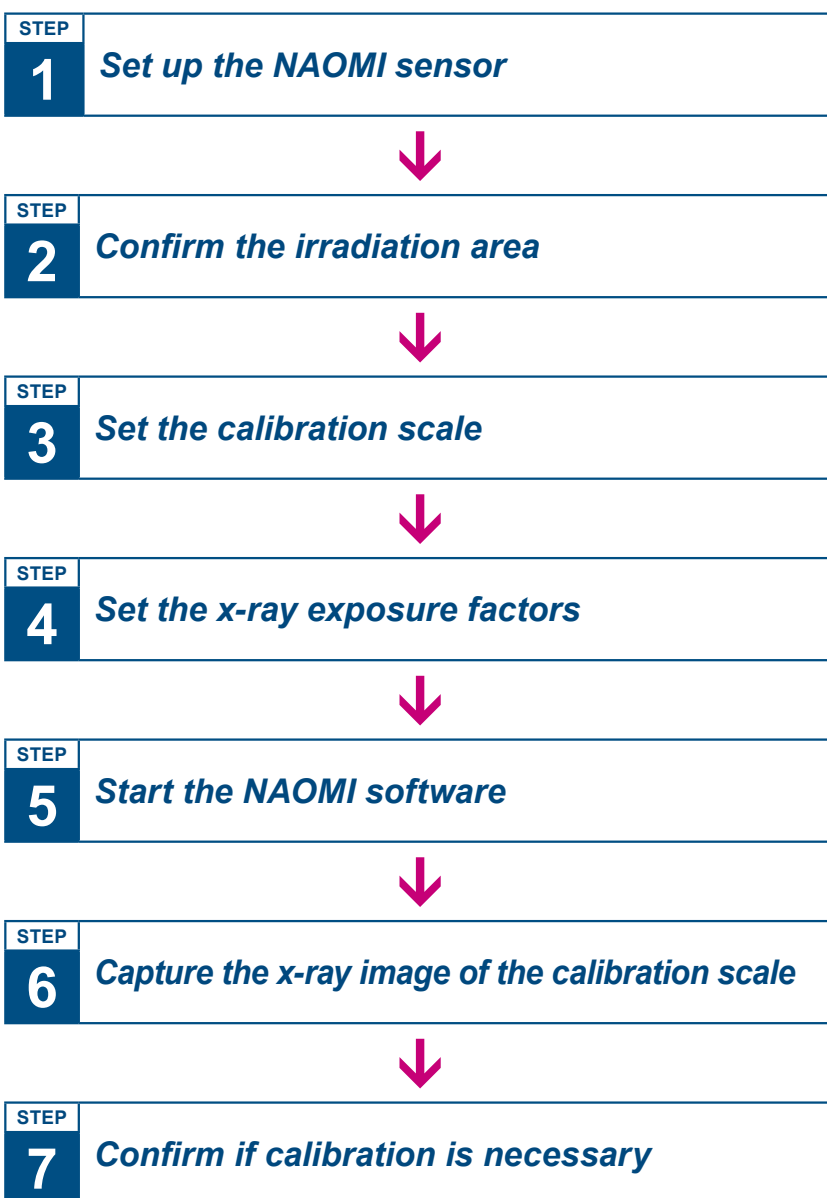

1 Set up the NAOMI Sensor

Place the sensor.

Plug in AC Adapter, Power Cable, and connect USB Cable.

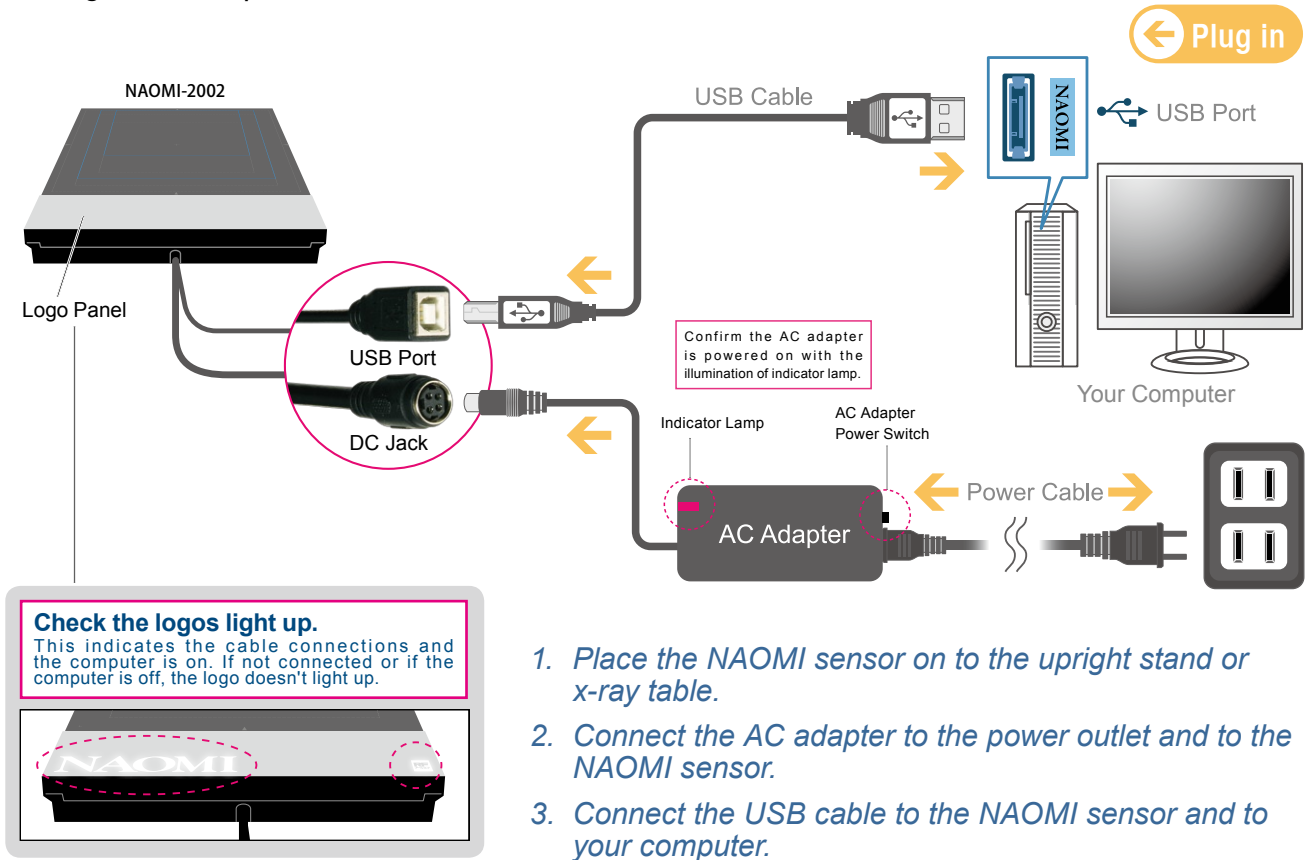

4 LEDs light up to indicate the condition of the NAOMI unit.

- Green: Power cable is connected properly.
- Light Blue: The sensor unit power is on.
- White: USB cable is connected properly.
- Green: Stand-By, and ready to detect the x-ray
- Dark Blue: Capture completes.



NOTE

If the NAOMI software and/or driver are not installed in your computer, refer to the Installation section (Driver: Installation 03-10, Software: Installation 11-15).



NOTE

Refer to the upright stand (or upright stand bracket) installation guide for the upright position setting.



CAUTION

Make sure to turn off the photo timer, electric bucky equipment, or any other equipment close to the NAOMI unit. The strong magnetic field may cause the malfunctioning on the image capturing process.

Confirm the Irradiation Area

Set the irradiation area larger than the sensor's imaging area.

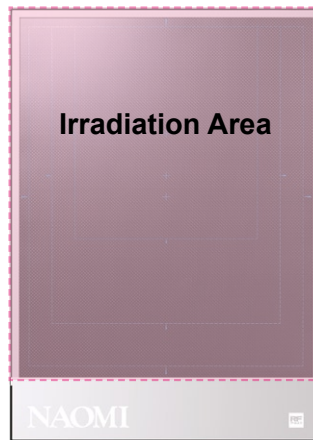

NOTE

Raise the x-ray tube to **approximately** 150cm (60 inch) or longer tube distance in order to set the irradiation area wide enough to cover the entire sensor.

NO **INCORRECT**
The irradiation area is not covering the entire sensor.



YES **CORRECT**
The irradiation area is covering the entire sensor.



NOTE

If your irradiation area cannot cover the entire sensor, contact RF Technical Support.

STEP

3 Set the Calibration Scale

Set Calibration Scale on the NAOMI sensor securely with Scale Pins.



Handle the calibration scale with care to avoid any injuries or crease on the scale.

Align to the Left

■ With the NAOMI-2000 series

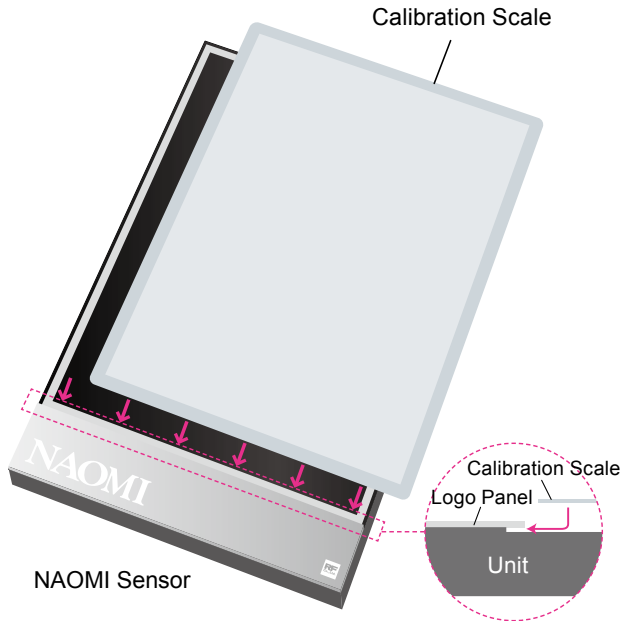
**NOTE**

Secure the Calibration Scale to the bottom edge behind the Logo Panel.

NOTE

Align Calibration Scale to the bottom of the NAOMI sensor, so that the NAOMI sensor detects Calibration Scale properly.

STEP

4 Set the X-Ray Exposure Factors

Set the x-ray machine to the following technique*:

Tube Distance	150cm - 180cm / 60" - 72" (as far as possible)
Tube Voltage	68kvp
Irradiation Strength	5mAs

- Recommended Tube Current : 100mA
- Recommended Exposure Time : 1/20 sec. (0.05sec. / 6 pulse)
The above equals to 5mAs.

*The technique value may vary depending on the x-ray machine or its tube distance.

STEP**5****Start the NAOMI Software**

1. Double click the NAOMI icon  on the desktop.

NOTE

If the NAOMI imaging software has not been previously installed, refer to Software Installation section (Installation 11 - 21).

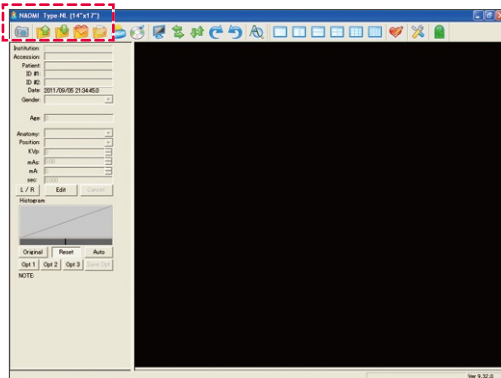

2. The software starts automatically.

NOTE

When the software recognizes the NAOMI sensor connection properly, it shows its model name of the NAOMI sensor. When it does not recognize the connection, it displays "NAOMI (Not connected)". Refer to Troubleshooting - 05 for details.

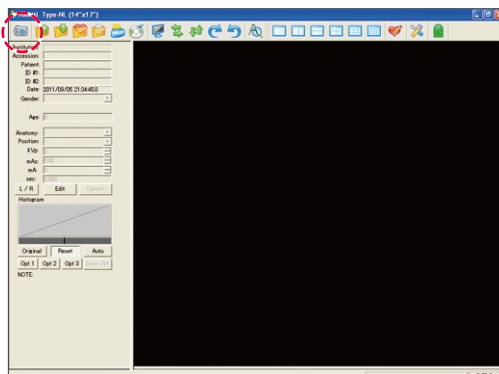
**STEP****6****Capture the X-Ray Image of the Calibration Scale**

1. Click the camera icon to prepare the software and the sensor for the exposure.
2. Type in ID.
Click Single.

NOTE

Refer to "How to Capture X-Ray Images" (Software 08-11).

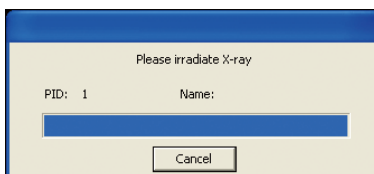

3. The message "Please irradiate X-ray" appears to indicate that it is ready for the irradiation.

Irradiate x-ray before the time runs out.

NOTE

The software starts counting down the remaining once the message appears on the screen. It alerts when the time is running out. It alerts 10 seconds remaining, 5 seconds remaining and when it is timed out.

NOTE

The image of the calibration scale will be downloaded and displayed on the screen.

Confirm if Calibration is Necessary

After the image is displayed, confirm if calibration is necessary, by comparing the image on the screen with three example images below. If the calibration process seems to be needed, refer to the Calibration section.

There is at least one area on the displayed image that...

Example Image A The dots are overlapping with each other in at least one area of the image.

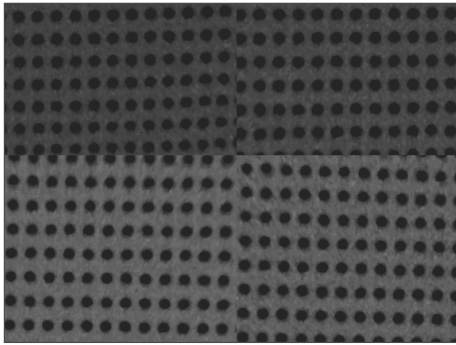

Enlarged View

If your image is...

- NO** Each dot is aligned with each other.
- NO** Each block of dots is even in contrast.

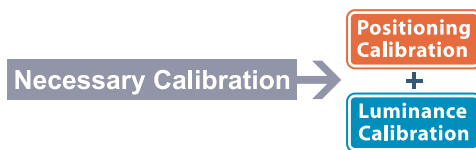

(Proceed to page Calibration / QAP 01-11.)

Example Image B The image contrast is not even.

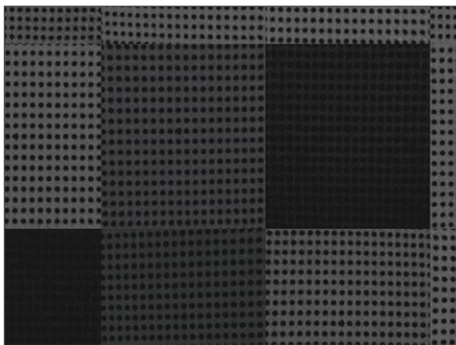

Enlarged View

If your image is...

- YES** Each dot is aligned with each other.
- NO** Each block of dots is even in contrast.



(Proceed to page Calibration / QAP 07-11.)

Example Image C The image does not have any overlapped dots or uneven contrast.

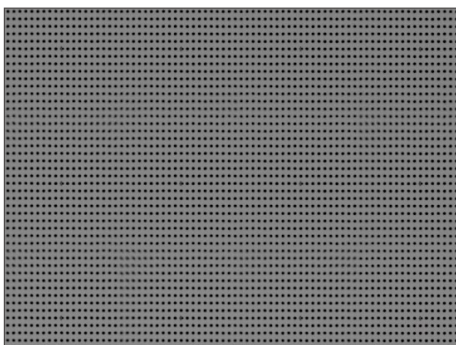

Enlarged View

If your image is...

- YES** Each dot is aligned with each other.
- YES** Each block of dots is even in contrast.

Necessary Calibration → **NONE**

Your sensor is ready to use.

(Proceed to next page.)

Ready to Use

If the displayed image looks like **Example Image C** in the previous page, your sensor is ready to use. Remove the calibration scale prior to start using the sensor.

REMOVE CALIBRATION SCALE.

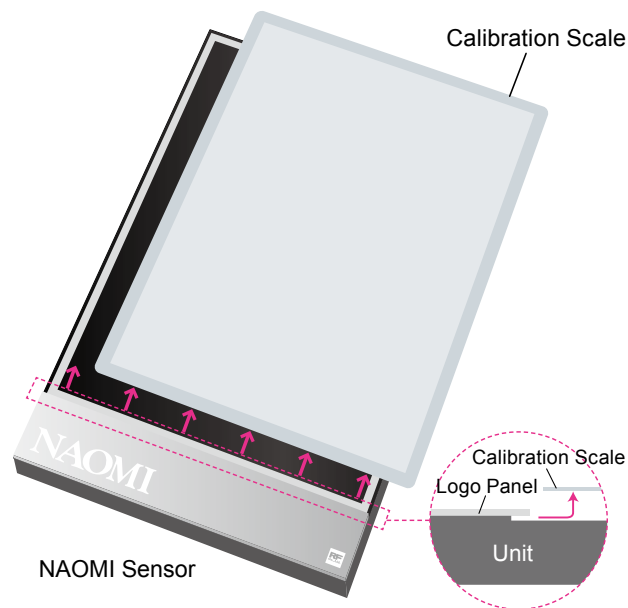

CAUTION

Handle the calibration scale with care to avoid any injuries or crease on the scale.



NOTE

Store the calibration scale and the scale pins where they are quickly available. They are necessary for the calibration process.

Now it is ready to use. Be sure to read the “Before Capturing X-Ray...” section in the software chapter (Software -05).

NAOMI Software

Start the NAOMI software.

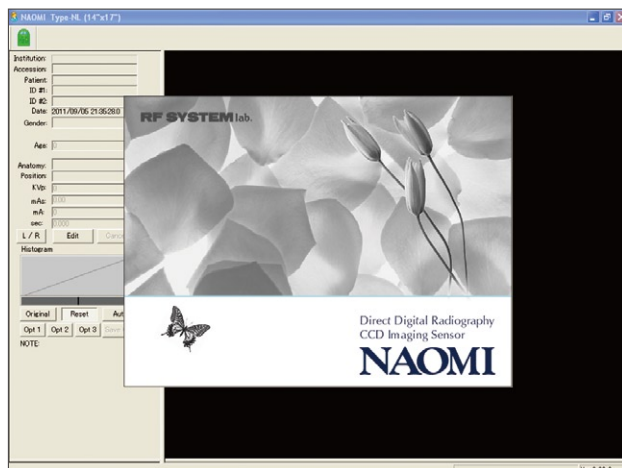

Double click the NAOMI icon on the desktop to start the NAOMI software.

NOTE

If there is no NAOMI icon on the desktop, install the NAOMI software. Refer to Software Installation section (Installation 11 - 15).

CAUTION

If the following error message pops up when double clicking on the NAOMI icon, **the software installation has not completed** (the part of NAOMI Software, Runtime Library is not installed). Go back to the installation page to complete the installation (Page Installation - 14).

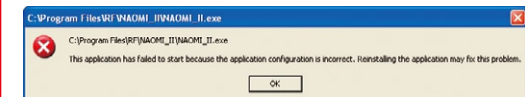

CAUTION

When the three error messages (below) appear just after you double click on the NAOMI software icon to start it up, you do not have a calibration map data (imaging data) copied in a proper folder. Go back to Page Installation 16 - 21 to copy the imaging data into the right location on your computer.

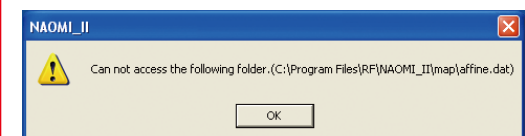

NAOMI software contains two different management modes.

A **Capture / Manipulation Mode** (Refer to Software - 02 - 03)

B **Patient Information Mode** (Refer to Software - 04)

A Capture / Manipulation Mode

Click the image screen area to change to Capture / Manipulation Mode.

Menu Bar
Refer to Menu Bar Icons.
(Page : Software-03)

Overlay: Patient Data

Image Screen

Overlay: Image Data Technique

Patient Data Menu
shows the patient's information of the selected image.

Histogram Window
shows the data of the selected image. The bar under the graph shows width and level of the adjustment setting.

Orange Frame
indicates the image is selected.

Software Version

Ruler in Centimeter.
Each scale is 1cm.









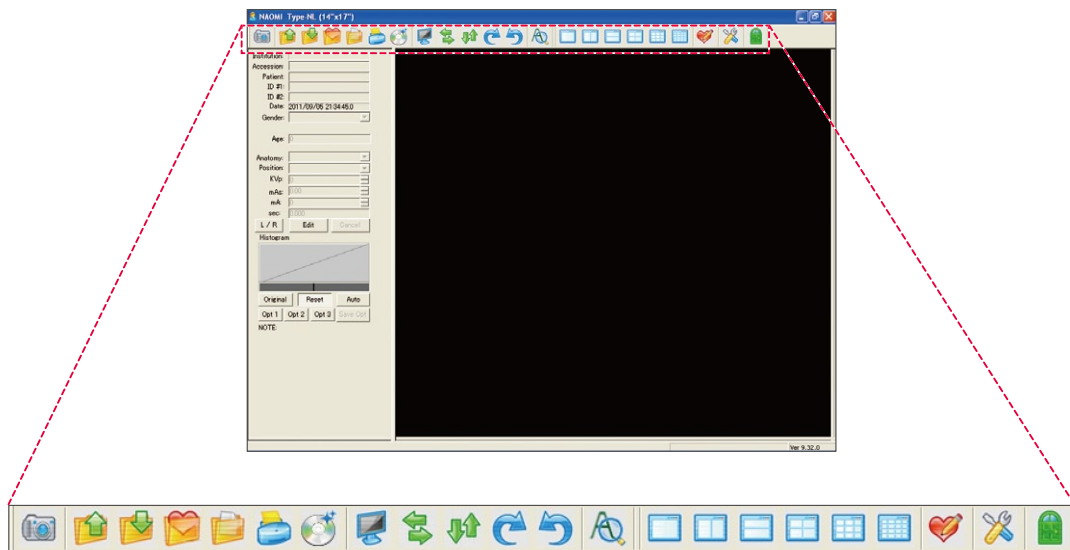













Overlay: Image Data Information
Fit, Mag: 100X ----- Magnification Scale
W: 1083 L : 3315 ----- Image Data
(Width = Contrast) (Level = Brightness)
DFOV: 48.4 x 57.9 ----- Display Field of View

NOTE By pressing **F11** key on the keyboard, display or hide Overlay Information (green imprints; Patient's Data, Irradiation Technique, and Image Data Information) on the image screen area.



Menu Bar Icons (in Capture / Manipulation Mode)



	Capture Icon	: Prepare the sensor and the computer for the x-ray irradiation and for a digital x-ray image capture.
	Open Icon	: Open the saved image.
	Save As Icon	: Save the selected image as a different file format.
	Update Icon	: Update (Save) the change of the adjustment in brightness, contrast, and gamma correction.
	Close Icon	: Close the selected image from the computer monitor.
	Print Icon	: Print out the selected image.
	CD Burning Icon	: Prepare the image data and the viewer software program to be burned on a blank CD-ROM/DVD-ROM.
	Negative/Positive Change Over Icon	: Reverse negative and positive.
	Reflection Icon (Horizontal)	: Invert the selected image horizontally.
	Reflection Icon (Vertical)	: Invert the selected image vertically.
	Rotation Icon (Clockwise)	: Rotate the selected image in clockwise by every 90 degrees.
	Rotation Icon (Counterclockwise)	: Rotate the selected image in counterclockwise by every 90 degrees.
	Enhancement Icon	: Turn On/Off the enhancement on the selected image.
	Single Window Icon	: Display one image.
	Double Window Icon (Vertical)	: Display two images vertically.
	Double Window Icon (Horizontal)	: Display two images horizontally.
	Quarter Window Icon	: Display up to four images on one window.
	3x3 Window Icon	: Display up to nine images on one window.
	4x4 Window Icon	: Display up to sixteen images on one window.
	Annotation Icon	: Open the annotation menu.
	Setup Icon	: Open the setup menu to change the NAOMI system's configuration.
	Exit Icon	: Close the NAOMI software.

B Patient Information Mode

Click the Patient Data Menu area to switch to Patient Information Mode.

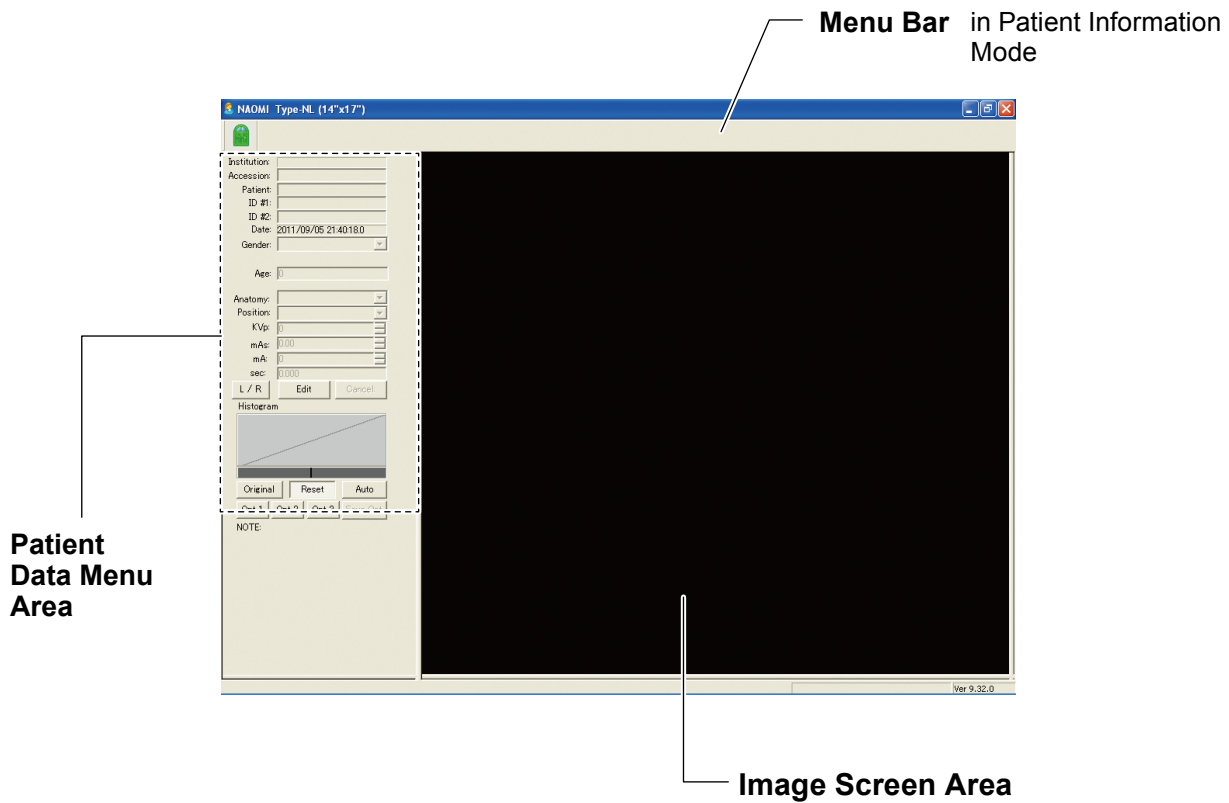

NOTE By pressing **F11** key on the keyboard, display or hide the Overlay Information (Green imprints; Patient's Data, Irradiation Technique, and Image Data Information) on the image screen area.



NOTE Click on Image Screen Area to go back to the Capture / Manipulation mode.

Before Capturing the X-Ray

This section explains the preparation steps in order to use the software more effectively. Please refer to the following instruction to set up your software before using the NAOMI system.

A *Check the file saving location.*

This is to check where the captured images are automatically saved into, so that the x-ray images can be managed easily (refer to Software - 06 for details).

B *Change the file saving location.*

This is to change where the captured images are automatically saved. If you already have a filing structure in the computer system you would like to use, you may select a folder in your computer to maintain the image files effectively (refer to Software - 07 for details).

C *Input the institution information.*

The institution or office name, department name, or office address can be saved with the acquired x-ray image data (refer to Software - 58).

D *Register a DICOM printer settings.*

If printing images by a DICOM printer* through a LAN connection, register a DICOM printer settings (refer to Software - 58 and Software - 28).

*Printer devices to print DICOM format image files onto a particular paper or film. Dry Imager Printer is one example.

1 Before Capturing the X-Ray...

The image is automatically saved in the folder, which is selected in Setup Menu. Prior to use, it is necessary to set the location for the captured images to be automatically stored.

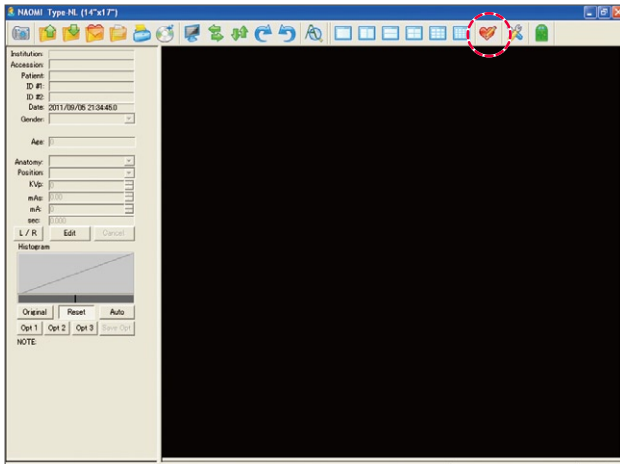

A. To check the folder's location

1. Click the Setup icon.

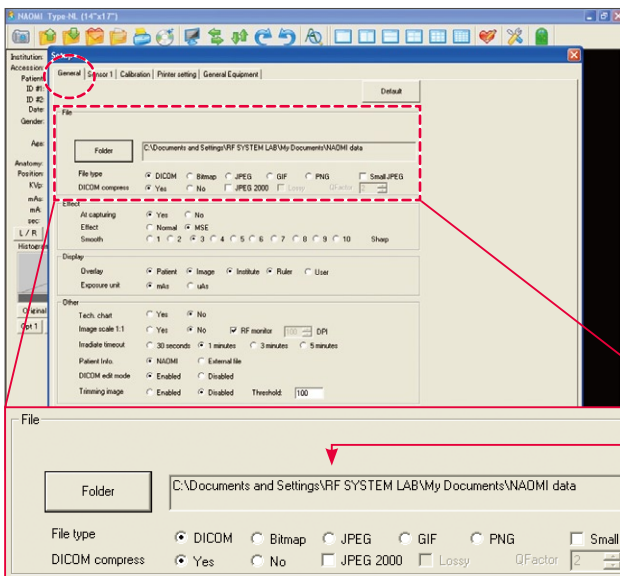

2. Setup Menu is displayed.

Select the **General** tab.

Check under "File". The folder's location is displayed next to the "Folder" button.

The folder's location: where the image is automatically stored.

File format type.

NOTE

The recommended file type is DICOM, because all patient information is stored with the image, and there is more pixel capacity on the image compared to other file types.

NOTE

The default location for images to be stored automatically, is set as "C:\Documents and Settings\Administrator\My Documents\NAOMI data"

(To access this folder, go to My Computer, Local Disk C Drive, Documents and Settings, Administrator, My Documents, and then NAOMI data.)

*This is only applicable to the NAOMI software, when it was installed to the default location during the installation process. If the NAOMI software was installed in a different location, the above does not apply.

Before Capturing the X-Ray...

B. To change the folder's location

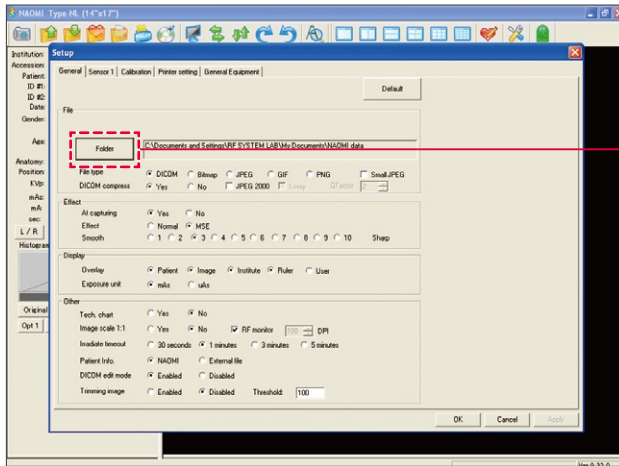

1. Click the "Folder" button.

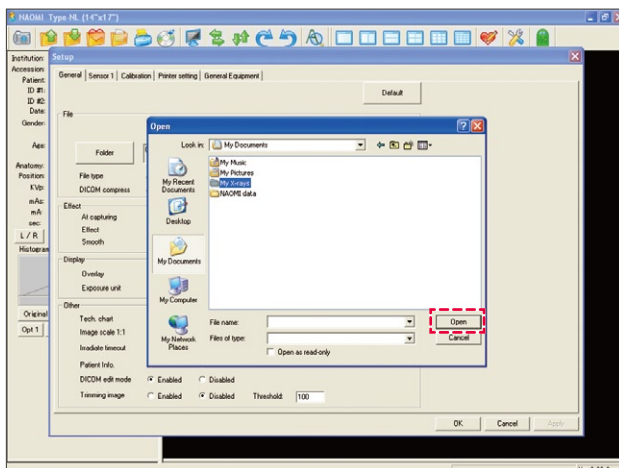

2. The open window appears.
Select the folder, where you wish to save images.

Example !

I would like to save images into "My X-Rays" folder, which I have created in My Documents.

- Step 1** Select My Documents
- Step 2** Select My X-Rays folder.
- Step 3** Click Open.

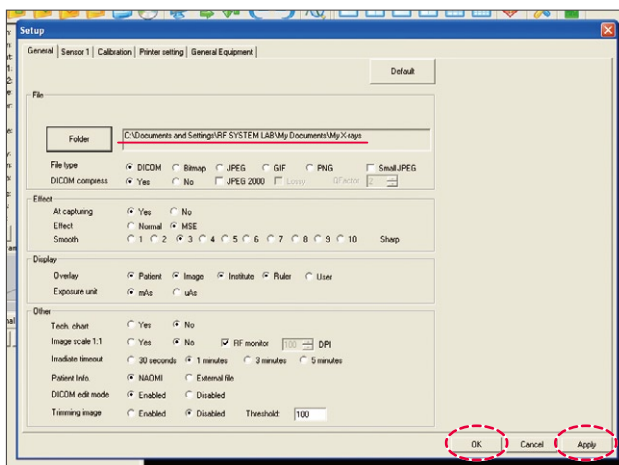

3. The selected folder's name will be displayed.

Click Apply and OK.

2 How to Capture X-Ray Images

Capture Mode

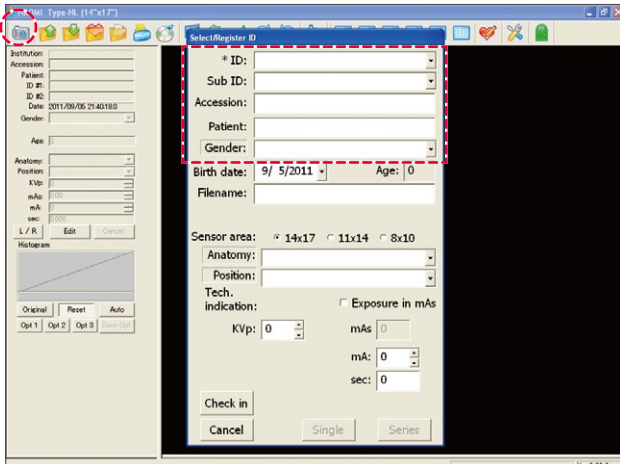

NOTE

Do not use a comma(,), when you type in the patient information.

Example

- ✗ Smith, Mike (comma)
- Smith_Mike (underscore)
- Smith-Mike (hyphen)
- Smith Mike (space)

1. Click the Camera icon  on the menu bar. "Select / Register ID" menu shows up. Type in ID, or select from the list by clicking the arrow next to ID.

The folder will be named the same as ID, and created in the location you have selected in Setup Menu. ID can be anything such as a carte number, a patient's name or a social security number.

[Sub ID]

This is optional. You may want to type in information other than the one you put in the main ID number. When you enter "Sub ID", the captured images will be saved under the Sub ID folder in the main ID folder.

Example !

- (1) (Main) ID : Patient Name
Sub ID : Name of Symptom
- (2) (Main) ID : Carte Number
Sub ID : Date of Visiting
- (3) (Main) ID : Client (or Company) Name
Sub ID : Patient Name

NOTE

The Capture button (Single and Series buttons) does not become available **without the ID number**.

[Accession]

This is an accession number of the image. Leave it blank, then the software issue an accession number automatically.

[Patient Name and Gender]

Type in a patient name and/or select a gender if necessary.

The information will be imprinted on the image.

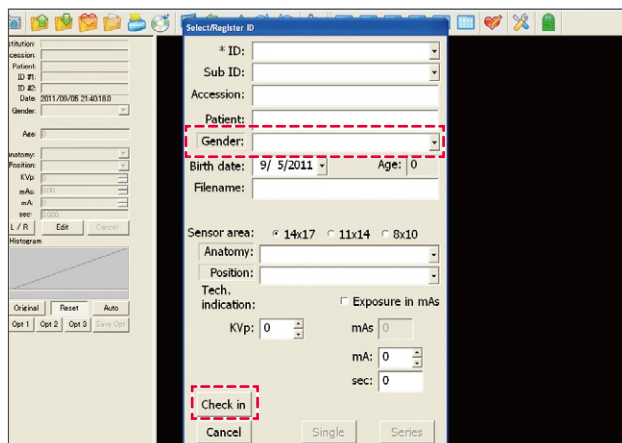

[Birth Date & Age]

When you type in the date of birth, the age will be automatically calculated.

[Check in]

Click this button to update the patient information.

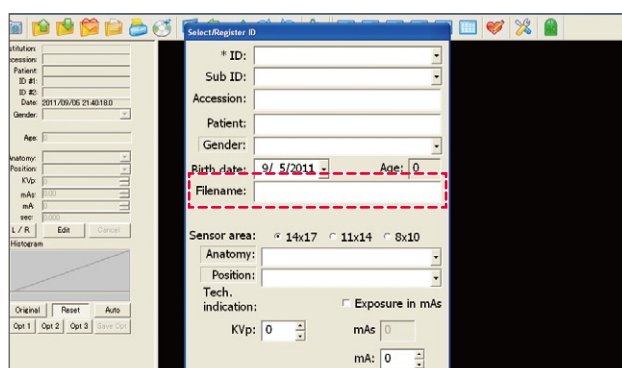

[File Name]

If the file name field is left blank, the image is named with the date and time at capturing.

NOTE

If the file name is left the same for the next x-ray, the message, "WARNING: The filename you have entered already exists. Continuing will erase the current file. Do you want to proceed?" will appear. By selecting "Yes" on this message, the previous captured image will be overwritten by the image to be captured next.

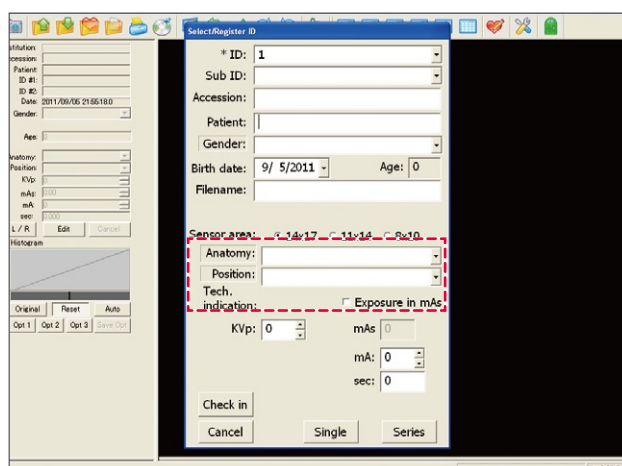

[Sensor Area]

Select the collimated sensor area size.

[Anatomy and Position]

Select the anatomy and position from the list if necessary. When selected, the information will be imprinted on the image.

NOTE

When selected, the anatomy will be added to the file name.

Example !

The file name of the image you captured at 11:00 on July 19, 2011 will be following:

without the anatomy information

2011_07_19_110000.dcm

with the anatomy information

2011_07_19_110000_CSPINE.dcm (by selecting "CSPINE" under [Anatomy]).

NOTE

The list of the Anatomy and Position information can be customized. Double Click directly on "Anatomy" or "Position", the list will open as a text data. Add and/or delete the item(s) as necessary.

How to Capture X-Ray Images

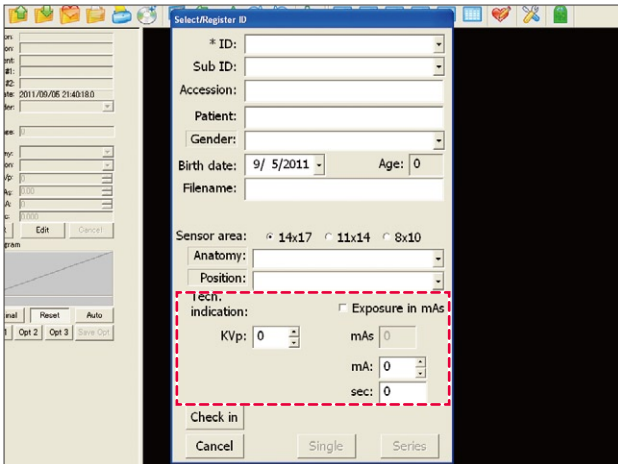

[Tech. Indication]

Click on the check box of “Exposure in mAs”, when the x-ray machine provides you the x-ray factor in mAs, not mA and sec. separately. They are a recording purpose, saved as the image data and shown as Overlay information (refer to Software - 02 and Software - 55 for Overlay).

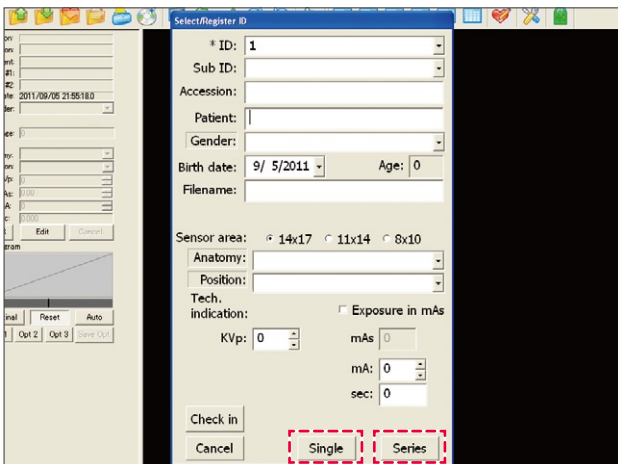

2. Click “Single” or “Series” to start capturing an image.

“**Single**”: Capture one image.

“**Series**”: Capture the series of x-ray images for the displayed patient. Each time the capturing completes, this menu window will be displayed with the same patient information

NOTE

Capture buttons (“Single” and “Series”) become available when you input the ID. Without typing the ID, they are not available..

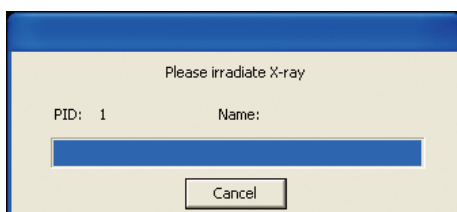

NOTE

The software starts counting down the remaining time once the message appears on the screen. It alerts when the time is running out. It alerts 10 seconds remaining, 5 seconds remaining and when it is timed out.

3. When you click “Single” or “Series” button, the message, “Please irradiate x-ray” appears.

Irradiate x-ray before the time runs out.

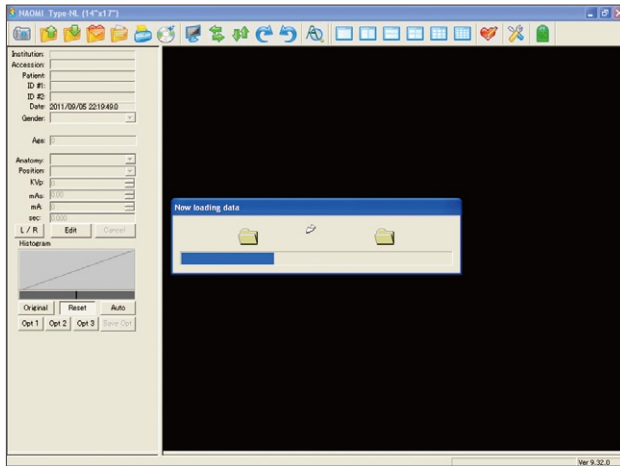

4. Once you shoot the x-ray, the image will be automatically downloaded.

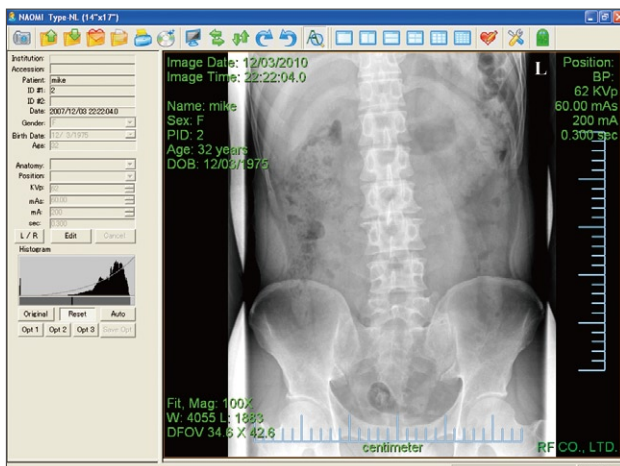

5. The x-ray image will be displayed.

How to Capture X-Ray Images

with Multi-Sensor Mode* (Two or More Sensors)

NOTE

* NAOMI sensors need to be set for the multi-sensor mode usage (using two or more sensors with one computer). It has to be instructed prior to the shipment of the sensors from the RF manufacturing site for this usage. If you need to use the existing multiple sensors with one computer under Multi-Sensor Mode, please contact RF Co., Ltd. for modifications.



1. Make sure to connect more than two NAOMI sensors to one computer. Then, double click on NAOMI Icon on the desktop, to start the NAOMI Software.

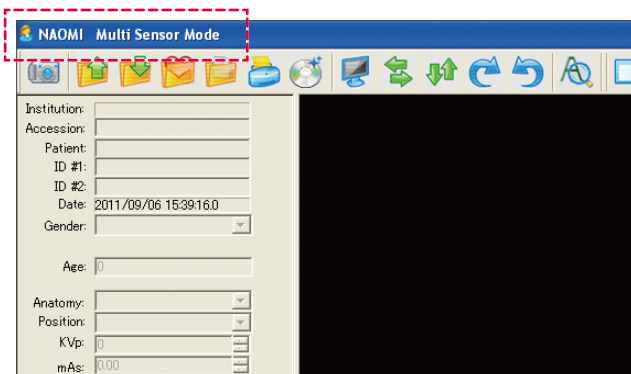

2. When the software opens, confirm the toolbar shows Multi Sensor Mode.

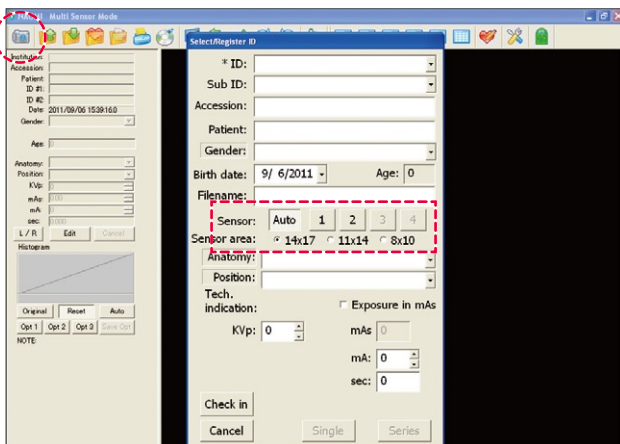

3. Click the Camera icon on the menu bar, to capture x-rays.
4. Select the number of the sensor you will be capturing an x-ray with. When selecting "Auto", the NAOMI sensor detects the x-ray automatically.

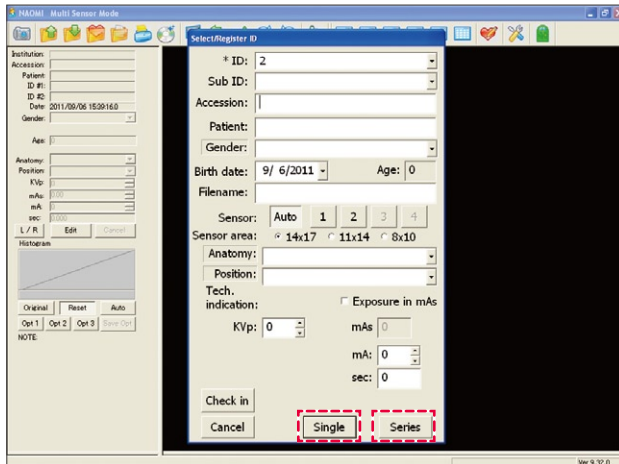

5. Type in the patient information, such as ID, patient name, gender, birth date, sensor area, anatomy, position, and/or technique settings. Then, click “Single” or “Series” to capture x-ray(s).

[Refer to Page “Software - 08 to 11” for details.](#)

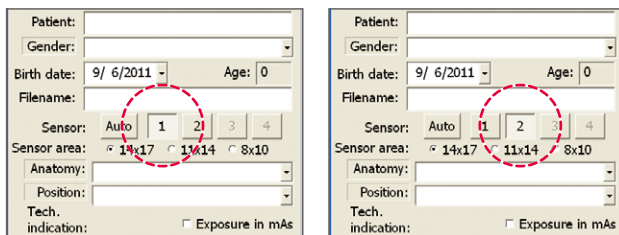

NOTE

When selecting “Auto” in Multi-Sensor Mode, in the process No.4, NAOMI sensor, which you are not taking the x-ray with, sometimes detects x-rays by accident due to the scattered radiation. In such case, select the sensor that you are working on.

How to Capture X-Ray Images

**with the foot switch
(Option)**

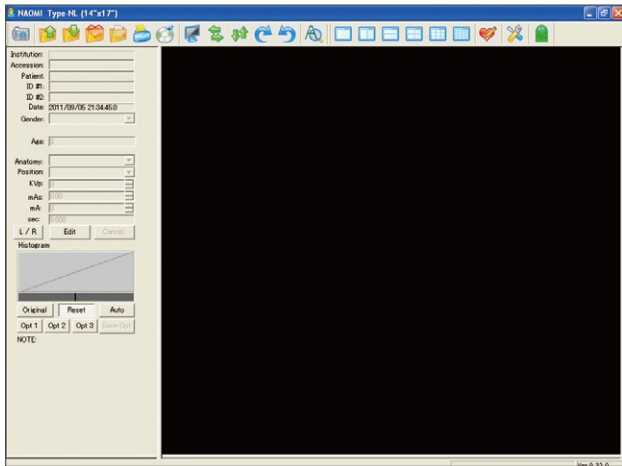

1. Press the foot switch.



[Option]

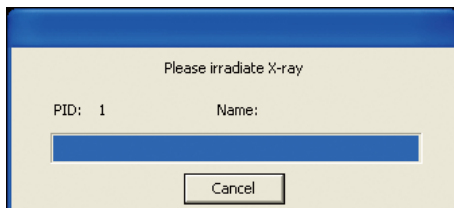

2. The message, "Please irradiate X-ray" appears.

Irradiate x-ray before the time runs out.

NOTE

The software starts counting down the remaining once the message appears on the screen. It alerts when the time is running out. It alerts 10 seconds remaining, 5 seconds remaining and when it is timed out.

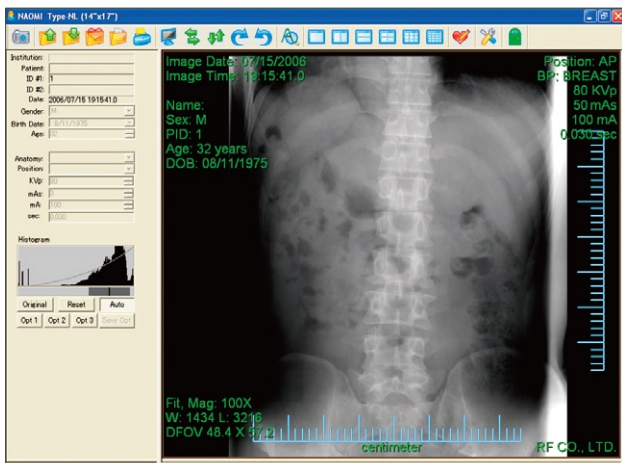

3. The x-ray image will be automatically downloaded and displayed on the screen.

NOTE

When taking X-ray with the foot switch, the image will be saved with the last ID and patient information you have used last time.

3 Zoom In / Out on the X-Ray Images

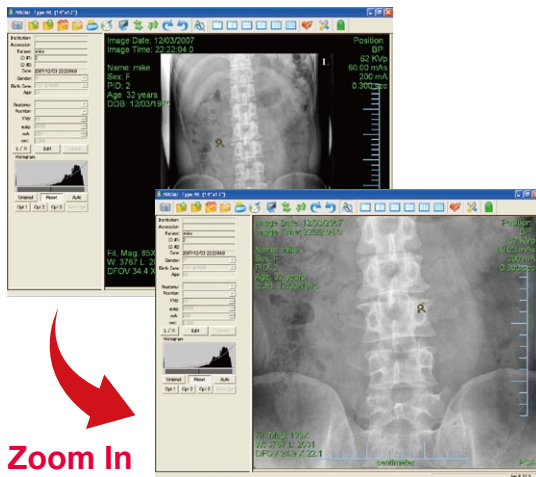

Zoom In

NOTE !

You can zoom in by pressing **+** key (**Fn** key + **+** key for laptop) on the keyboard. You can go back to x100 view by double-clicking the right button.

Zoom In

Select the image. Press the scroll button and drag **DOWN** to zoom in.

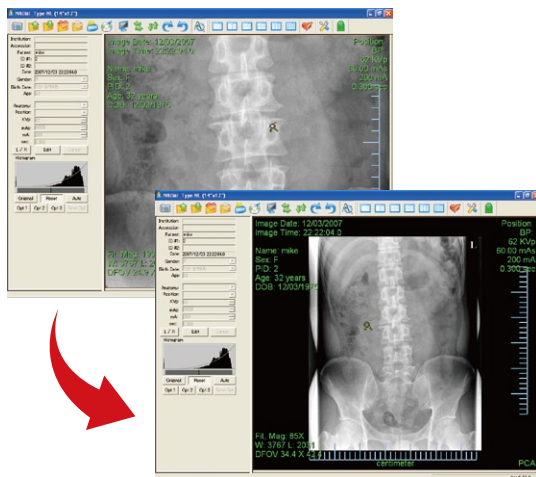
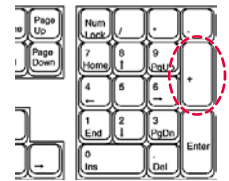
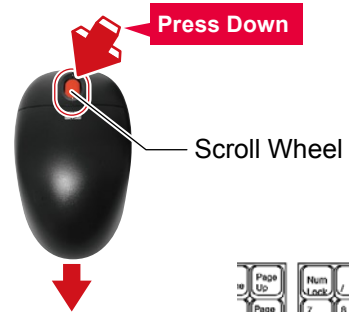

Zoom Out

Zoom Out

Select the image. Press the scroll button and drag **UP** to zoom out.

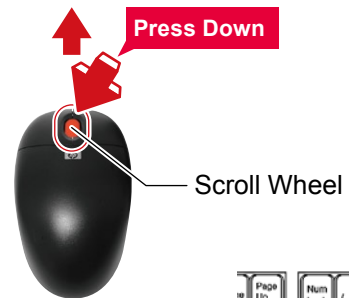

NOTE

You can zoom out by pressing **-** key (**Fn** key + **-** key for laptop) on the keyboard. You can go back to x100 view by double-clicking the right button.

NOTE

While holding the scroll button down, the cursor changes to Magnifying Glass Pointer. While the cursor becomes pointer, you can zoom in and out the image.



4 Move the Image

Move the Image

Select the image.

Click **LEFT** and drag the mouse to move the image.

NOTE

To display the image at the center, double click on the right button on the mouse.

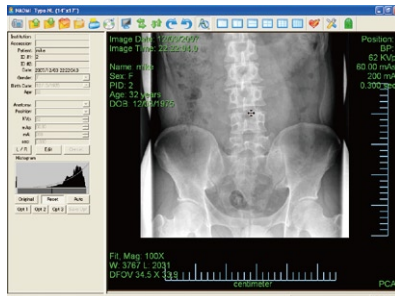

Up



Click and Drag

Left



Right



Down

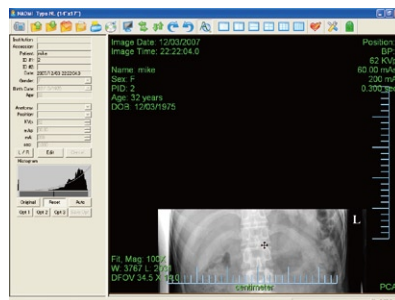
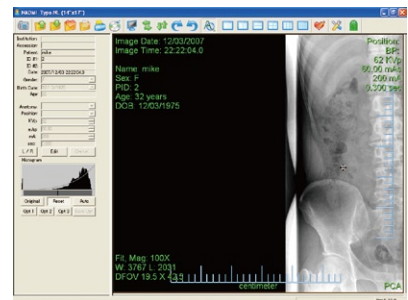
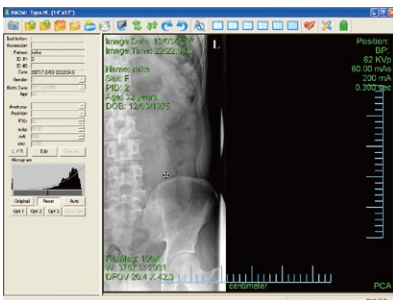

NOTE

Once the left button is clicked, the cursor changes to 4 Directional Pointer until the left button is released. While the cursor becomes 4 Directional Pointer, you can move the image.

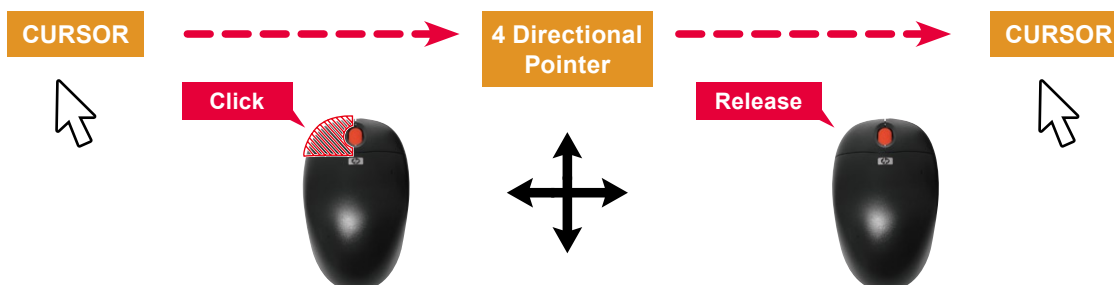

5 Adjust the Brightness / Contrast

Brightness / Contrast

Select the image.

Click **RIGHT** and drag the mouse to adjust brightness and contrast.

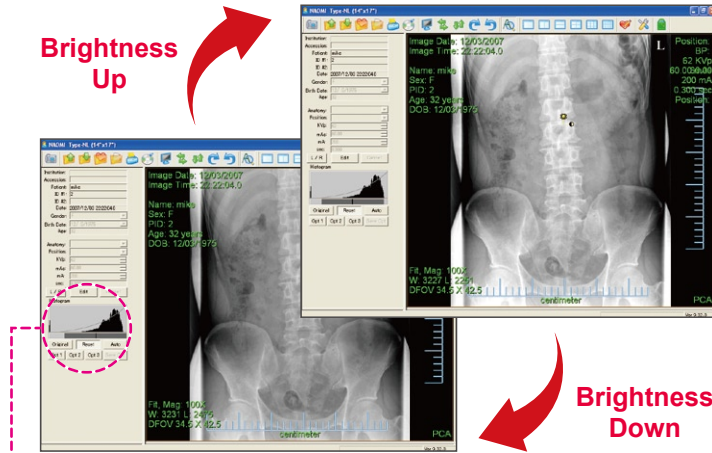

*The number and the histogram of level changes as you change the brightness.

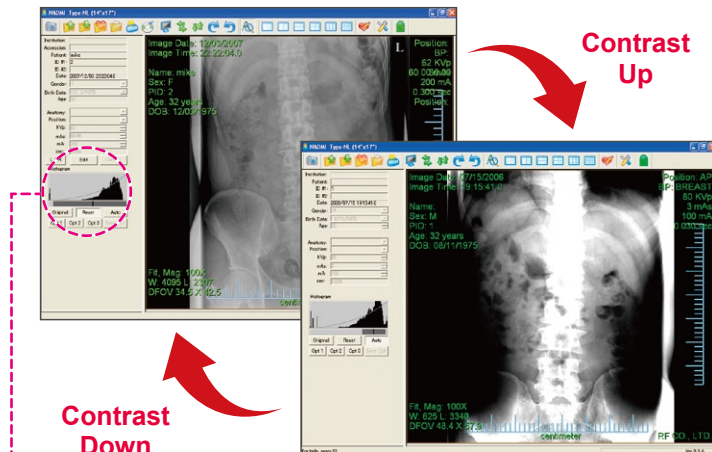

*The number and the histogram of width changes as you change the contrast.

Brightness

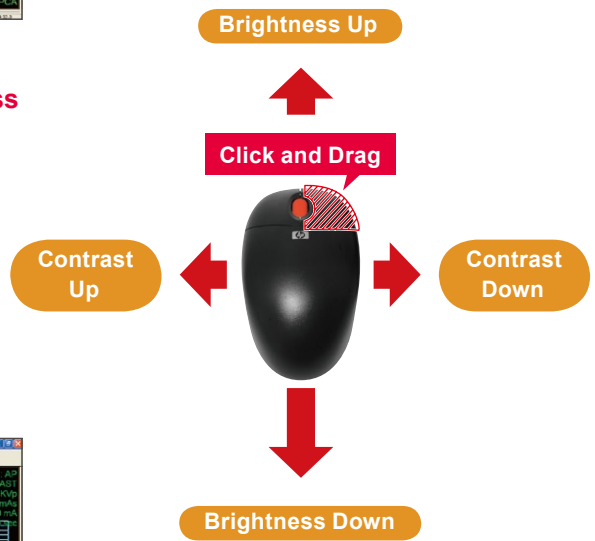

Contrast

NOTE

Once the right button is clicked, the cursor changes to Image Adjustment Pointer until the right button is released.

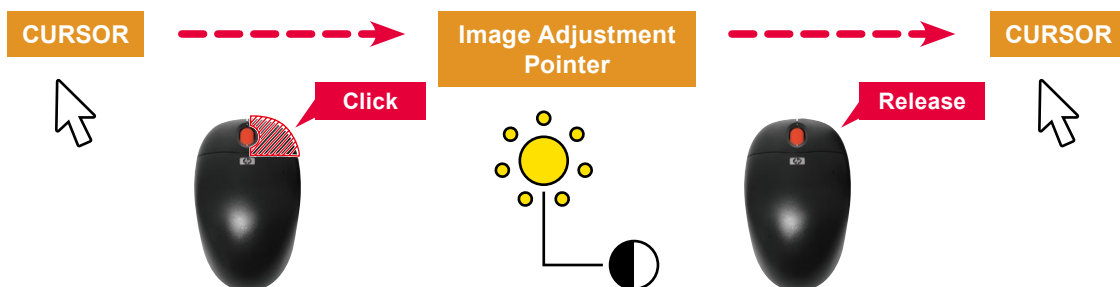

6 Adjust Gamma Setting

Gamma-Correction

Select the image.
Scroll the wheel **UP** or **DOWN** to adjust the gamma-setting of the image

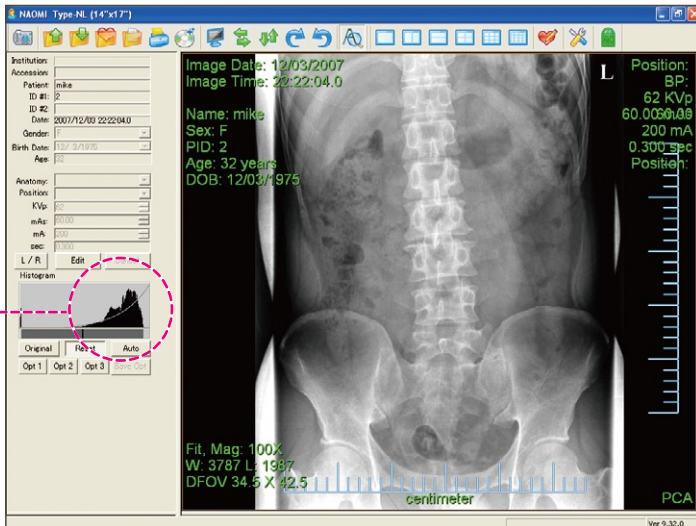

Darker

Scroll **up** Darker

Scroll **down** Brighter

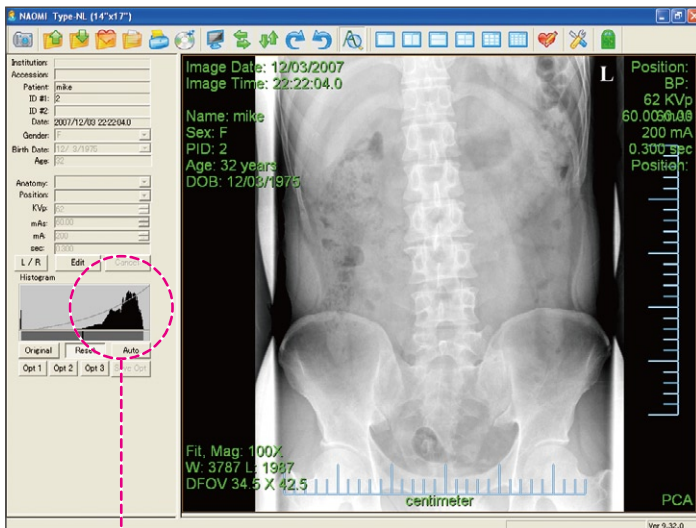

Brighter



*The curve of the histogram changes to indicate gamma-correction adjustment.

7 How to Adjust the X-Ray Images

One-Click Image Adjustment

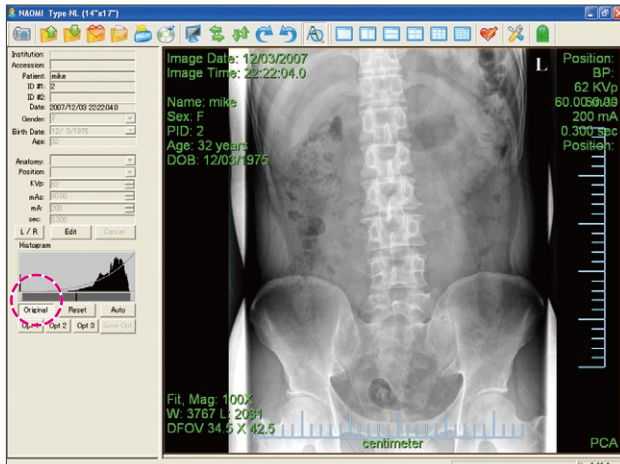

Original (Original Adjustment)

Click "**Original**" to go back to the adjustment setting, which has been previously saved on the image file.

(Refer to Software - 23)

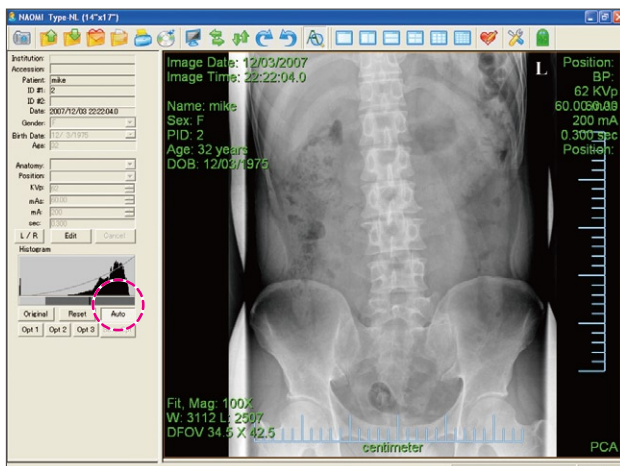

Auto (Automatic Adjustment)

Click "**Auto**" under Histogram. It automatically optimizes the brightness, contrast, and gamma-correction of the selected image.

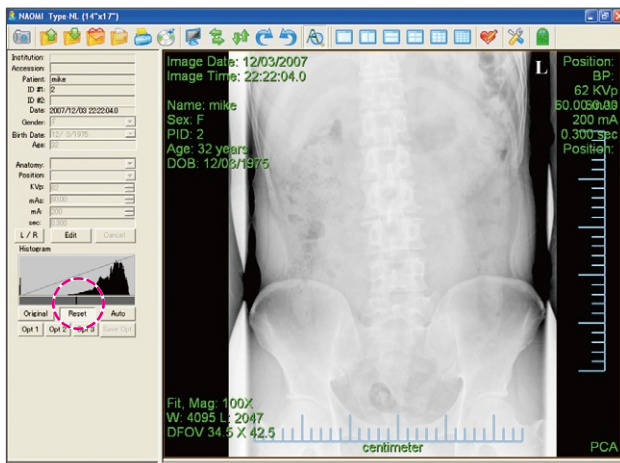

Reset (Resetting Adjustment)

Once clicking on "**Reset**", the adjustment setting will return to the raw data image (Originally captured image).

Preset Function

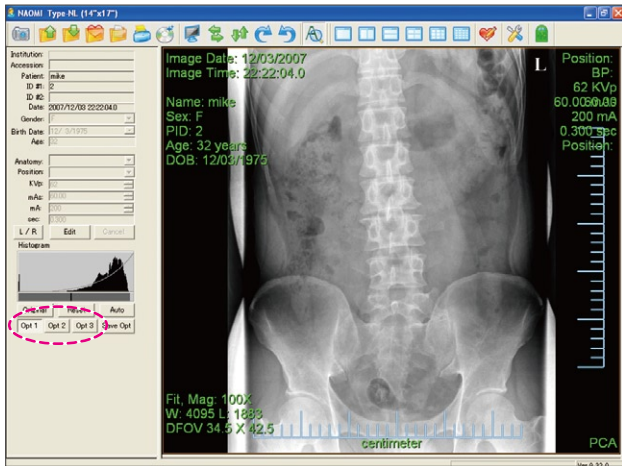

Opt 1 (Customized Adjustment)

1. Click "**Opt 1**" (Option 1), "**Opt 2**" (Option 2), or "**Opt 3**" (Option 3) button.
2. Change the brightness and contrast by right-clicking the mouse and/or the gamma-correction by scrolling the scroll wheel.

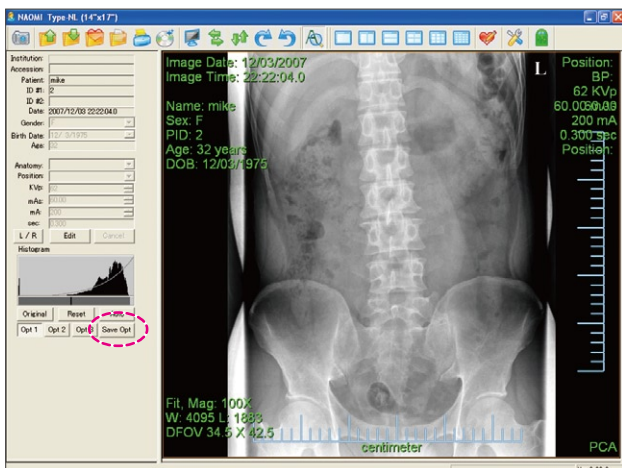

3. Click "**Save Opt (option)**" button to save the adjustment you have made to the displayed image.

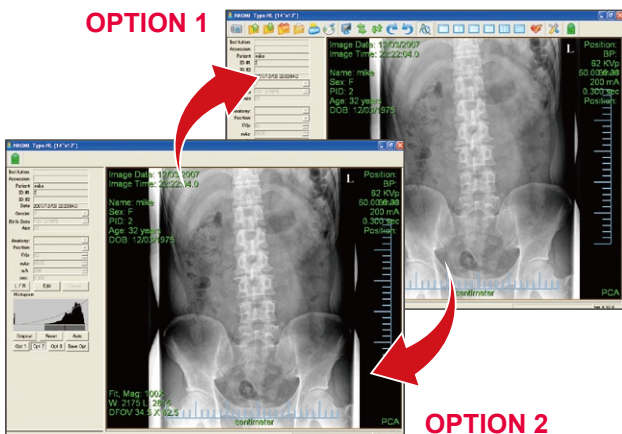

Once you save the adjustment setting to the option button, you can recall the same adjustment condition by clicking the same option button for any displayed images.

Example !

You can save the adjustment condition focusing more for abdomen on Option 1, chest on Option 2, and spine on Option 3.

8 How to Edit Patient Information or X-Ray Technique Records

DICOM Edit Mode allows you to edit the patient information (ID or name), and the x-ray technique records such as kVp, mAs, or body position or anatomy information.

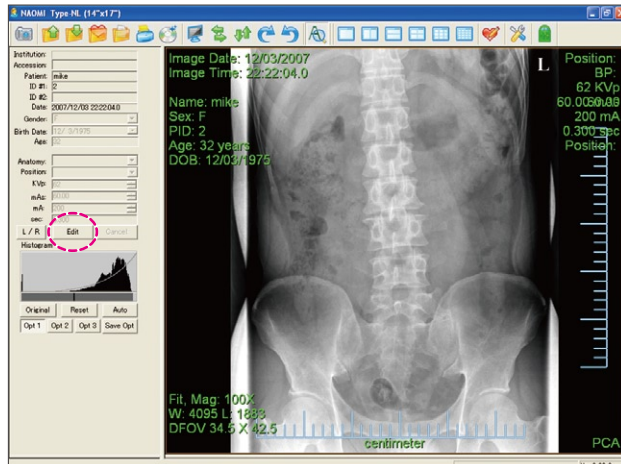

1. Click on “Edit” to enable the DICOM Edit Mode.



This is only available when the image is saved as the DICOM file format.

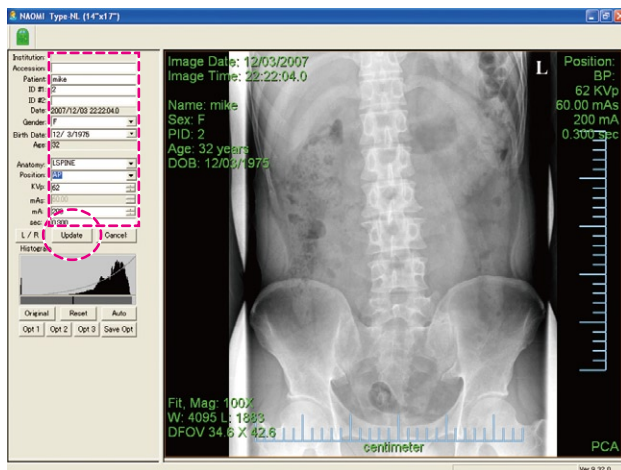

2. Edit where you wish to change the information.

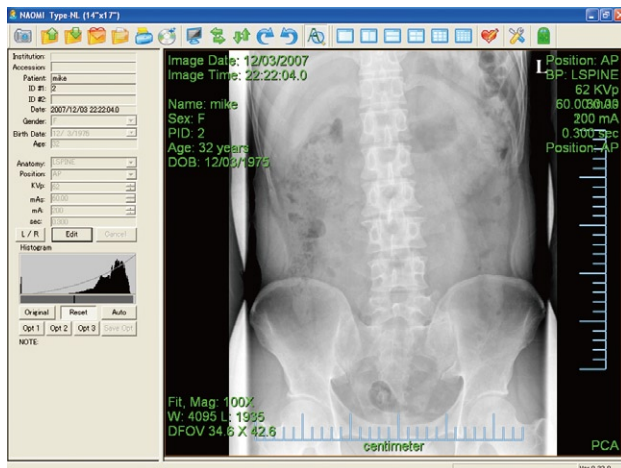

3. Click “Update” to save the changes.



When you mistyped the patient ID and have edited the ID, the saving location for the saved image needs to be changed as well. Refer to Troubleshooting -07 for details.

9 How to Add L or R Marking

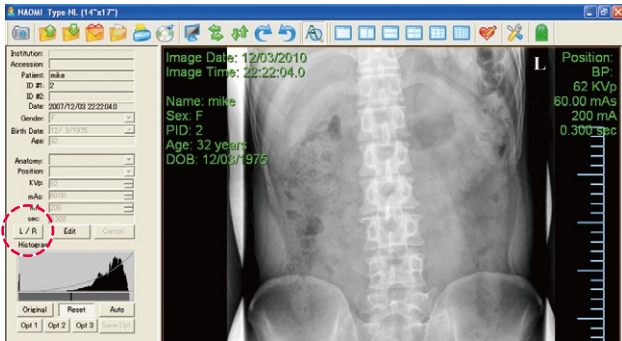

1. Click on "L / R" button.

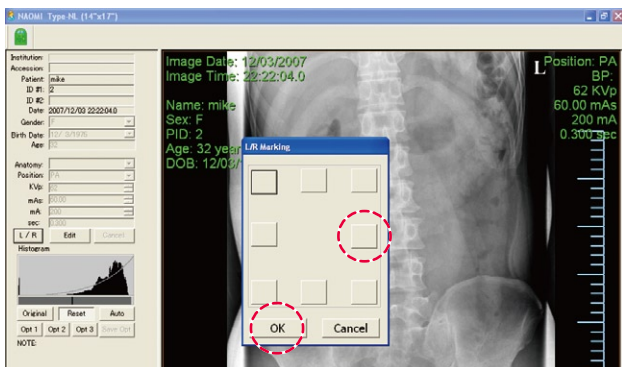

2. "L/R Marking" window shows up. Click the position where you want to add L or R
Click to switch to L, to R, to no mark.

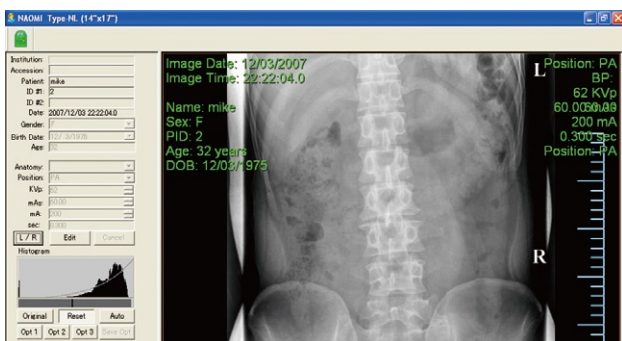
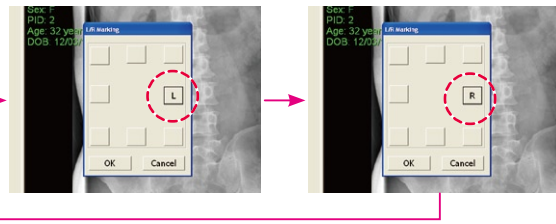

3. Click "OK" to add a mark.

NOTE

The change in L or R marking will be saved automatically without clicking "Update Icon" on Menu Bar. However, click "Update Icon" to save the change in brightness or contrast.

To Remove the Imprinted Mark from the Image File...

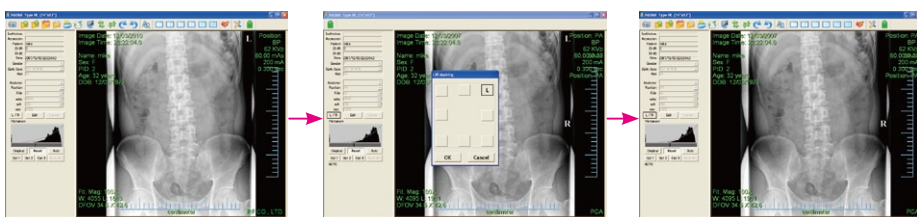

Click on "L/R" button, and select the same mark with the one imprinted on the image at the same position. This overwrites the same mark and remove it off. Be careful that this overwrites the same mark in a black color. Thus, the black mark appears if the imprinted mark was on the white area of the image and cannot be deleted.

10 How to Save the Adjusted Image

Once you find out the appropriate image adjustment level for your clinical application, save it for the future review. DICOM image can save its adjustment setting.

Update Icon

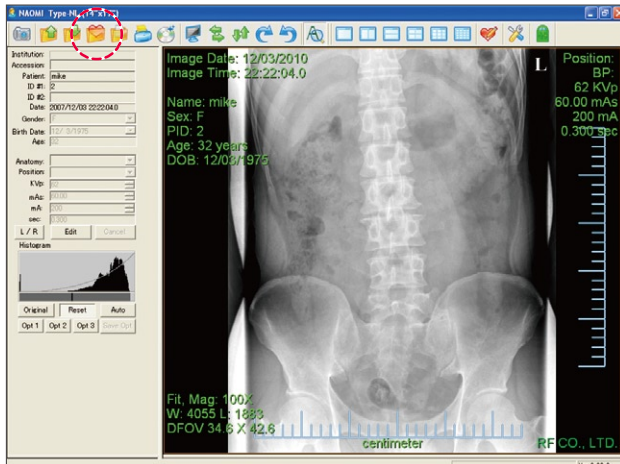

You can update the original data by clicking "Update Icon" on Menu Bar as well. It saves the changes in the contrast, brightness, and gamma-correction.

NOTE

Use caution to update your data. If the image data is saved in other than DICOM file format, the original image data will be erased and overwritten with the adjusted image data. If the image data is saved as DICOM file format, the original data is stored with the adjusted data, so it will not be overwritten.

NOTE

To display the image with the saved adjustment level, click on "Original" button under the histogram (refer to Software - 19).

11 How to Save as a Different File Format

Save As Icon

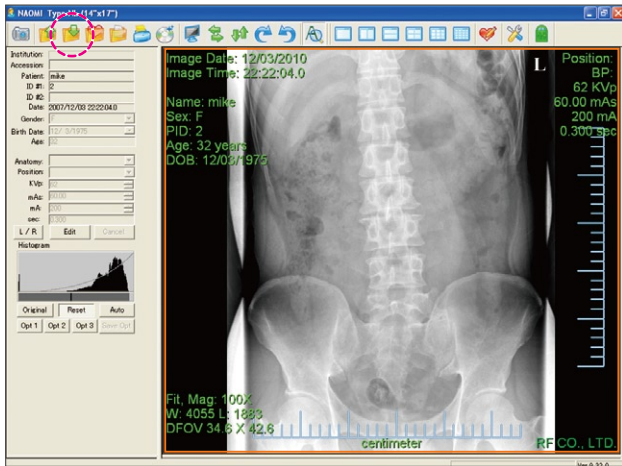

1. Select the image you wish to save as a different file format. And click on "Save As Icon".

NOTE

The selected image is highlighted in orange.

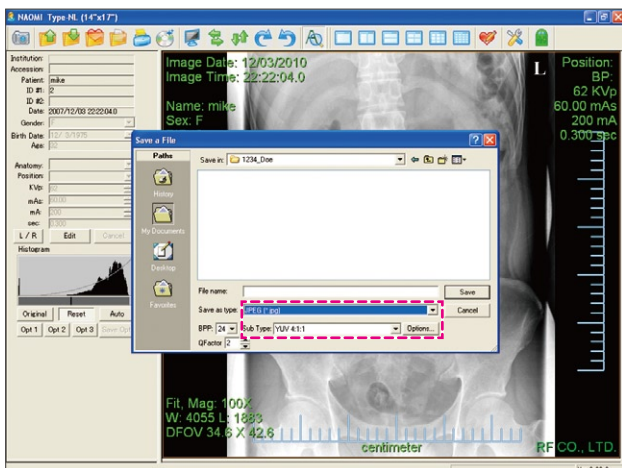

2. "Save a File" window appears.

Type in the file name.

Select the file type, BPP (bit per pixel), Sub Type (compression type) and QFactor (recommended as 2) as you need.

NOTE

You can save as:

DICOM, BMP(bitmap), JPEG, PNG, GIF

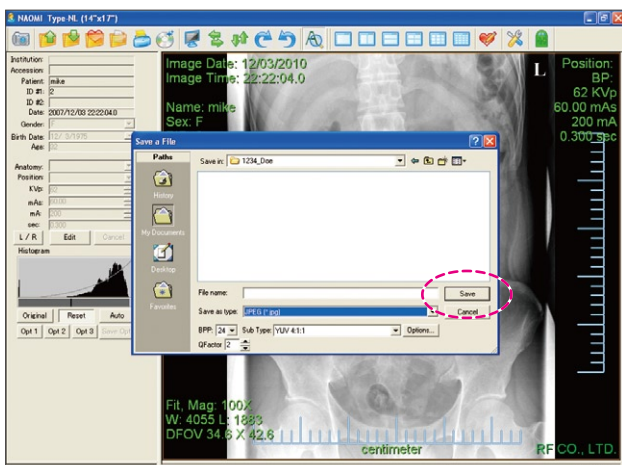

3. Click to save the selected images with the selected file format.

12 How to Open the Saved Image

Open Icon



1. Click the Open icon.

NOTE

You may check the automatic file storage location on the Setup Menu (refer to page Software - 06).

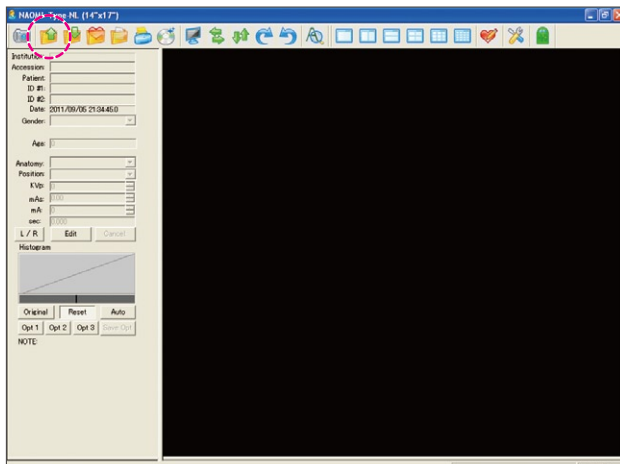

2. "Open" window appears.

Select the ID folder, then the file you wish to open.

NOTE

You can select multiple images by holding **ctrl** key and directly clicking on the file names. Do not select any annotation file (.ann) when trying to open multiple images at once.

NOTE

The following files can be opened with NAOMI software: DICOM, BMP(bitmap), JPEG, PNG, GIF

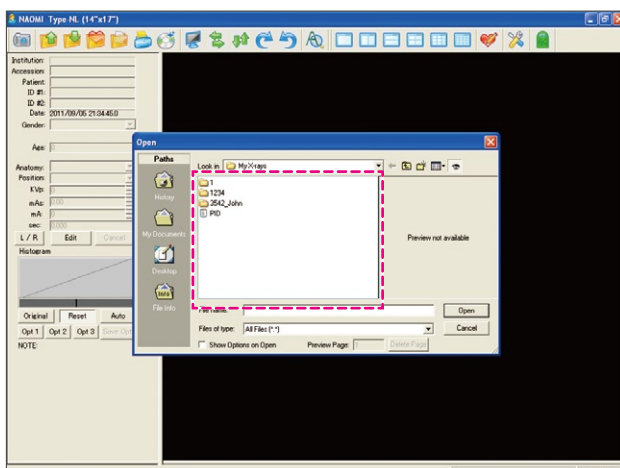

3. Click **Open** to open the saved images.

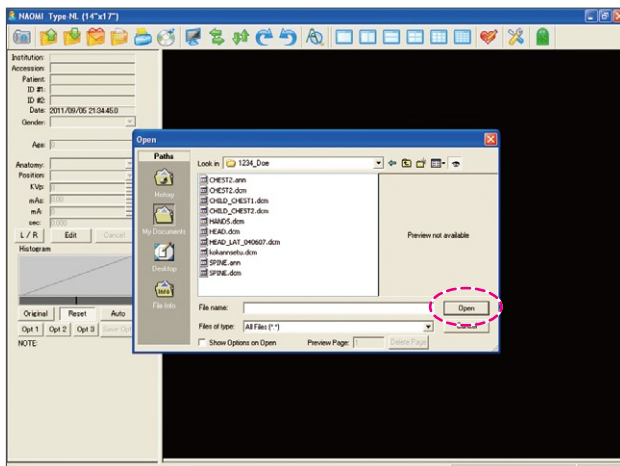

How to fix the open folder location with Windows 7

On Windows 7, Open Folder will direct you to the folder you opened last time, not into the saving location. To have Open Folder to direct you to the saving location folder, the computer setting has to be changed.

1. Go to Control Panel.
2. Click on Appearance and Personalization. And click on Folder Options.
3. On General Tab, under "Navigation Pane", Click on "Show all folders" (refer the figure below).
4. If the saving location has already been saved, it has to be set again to make the change effective.
 - (a) Open the NAOMI software.
 - (b) Go to Setup Menu.
 - (c) Change the saving location to a temporary place (any place is OK).
 - (d) Click on Apply and OK to close the Setup menu.
 - (e) Click on Open icon on the top and open any files.

You have to open something once to make the change effective.
 - (f) Go to the Setup menu again, and change the saving location to the location which you want.
 - (g) Click on Apply and OK to close the Setup menu.

Then, the Open Folder will direct you to the folder you have set as the saving location all the time.

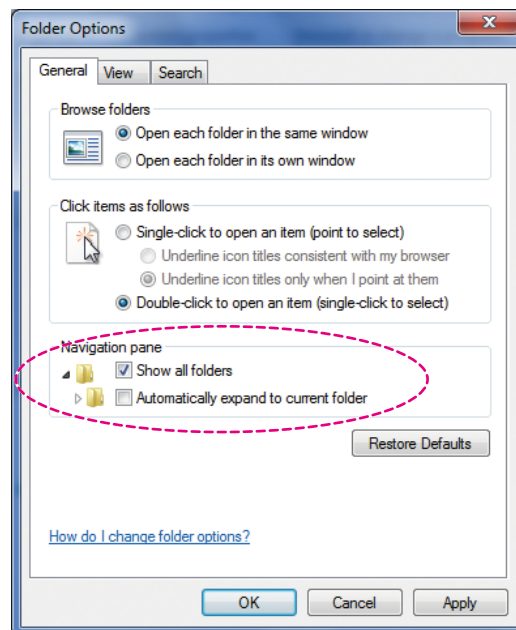

13 How to Close the Selected Image

Close Icon

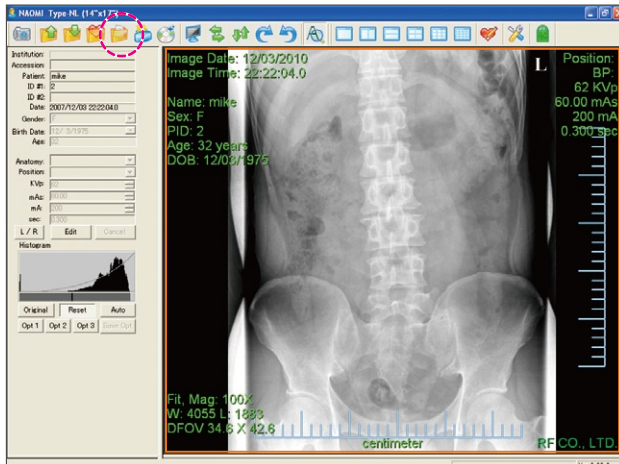

1. Select the image you wish to close.
Click the Close icon.

NOTE

The selected image is highlighted in orange.

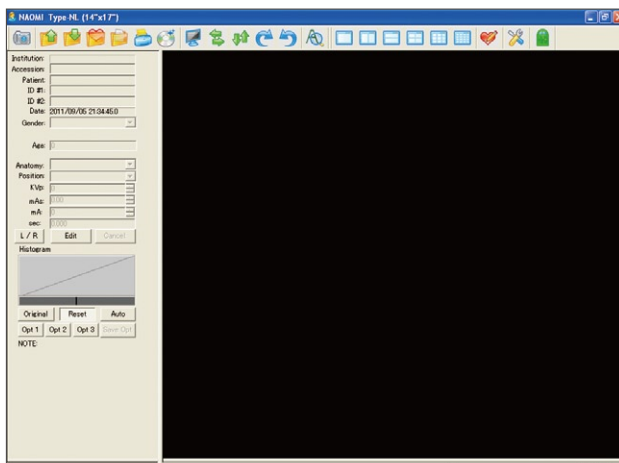

2. The selected image is now closed.

NOTE

To reopen the file, refer to "How to Open the Saved Image" (Page: Software - 25-26).

14 How to Print the Selected Image

※ DICOM Printer needs to be set up prior to use. Refer Software-58 for detail.

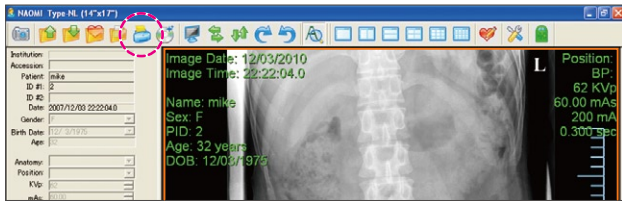

1. Select the image you wish to print. Click the Print icon.

NOTE

The selected image is highlighted in orange.

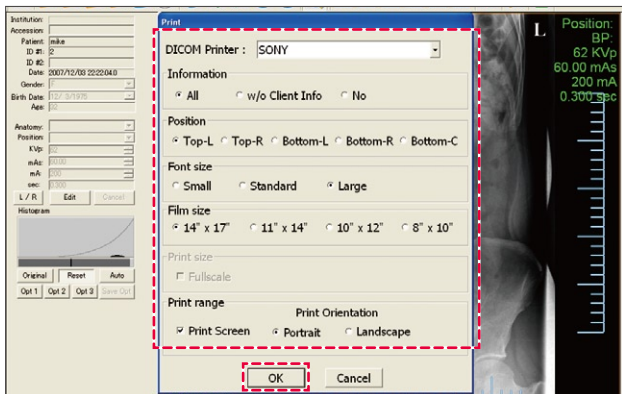

DICOM

2. The Print window appears. Select a corresponding option, depending on a printer in use.

DICOM printer selection

Select a DICOM Printer when multiple DICOM printers are connected.

Information (Patient Information)

- **All:** It prints all of the client information.
- **w/o Client Info:** It prints the information other than the client's information. (The client information includes client's ID, client's name and gender.)
- **None:** It does not print any information. It only prints the image you have selected.

Position

Select of the position where the patient information is to be printed whether on top-left, top-right, bottom-left, or bottom-right. Available for both a DICOM and normal printer.

Film size

Select a printing film size with a DICOM printer which has a capability to print multiple film sizes.

Print mode

- **Fullscale:** It prints with an actual size no matter which film size or paper size is selected.
- **Center:** Print the selected image at a center position on a film or paper.
- **Split:** Print the selected image on two film or paper in half by half.

Print range

- **Print Screen:** Print multiple images as displayed on the main screen (print four images when displaying four images by clicking Quarter Window icon (refer to Page Software-39)).

*Print Size will not be effected when you select Print Screen.

Print orientation

Select the orientation for printing as portrait or landscape.

Click .

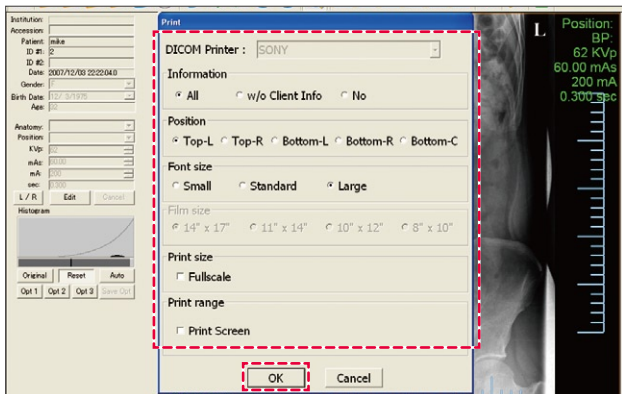

Normal

3. The Print window appears. Select the printer you wish to use. Click .

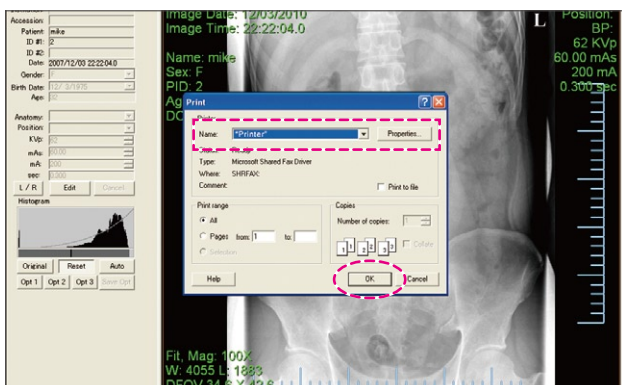

**CD Burn Icon
(Windows XP)**



Click on the CD icon.

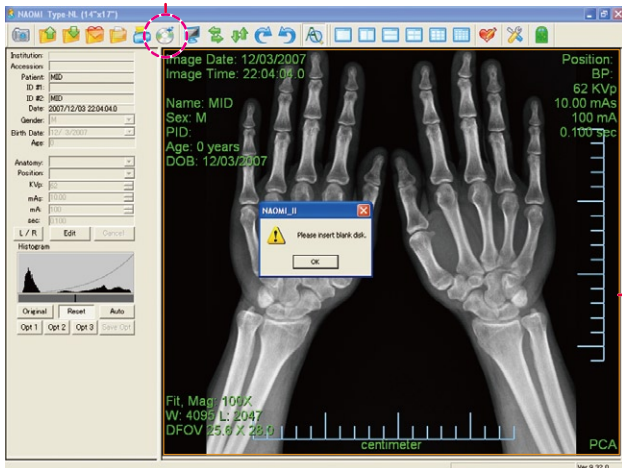

1. Display the image(s) you would like to burn on the CD-ROM. Make sure the image is selected (shown with the orange frame), then, click on CD icon.

Orange frame shows you the image you have selected.

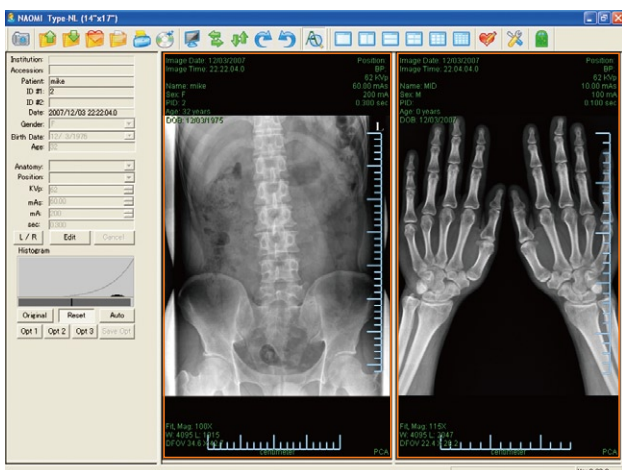

POINT

To burn multiple images, you select more than one images you want to burn on CD. Make sure that images you want to have on CD are selected and with the orange frame.

NOTE

Press and hold **Ctrl** key then select two or more images to have multiple selection.



2. The software automatically prepare the selected image(s) together with the NAOMI.app folder (viewer software program).

How to burn x-ray images on to a CD-ROM (Windows XP)

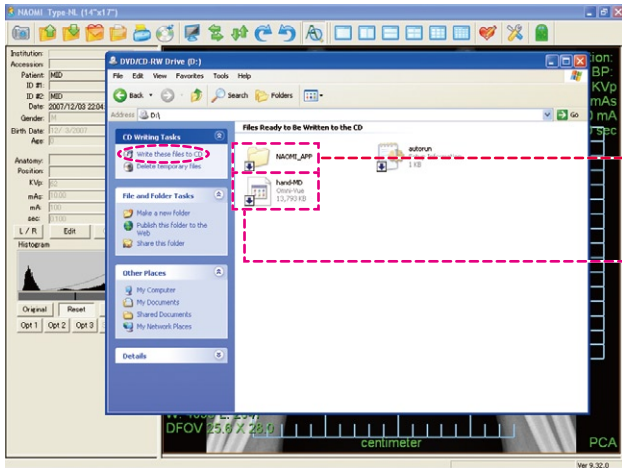

3. Insert a blank CD or DVD. These files are ready to be burned onto a blank CD. Click "Write these files to CD" to burn a CD.

This folder contains the NAOMI VIEWER software program.

The image file you have selected.

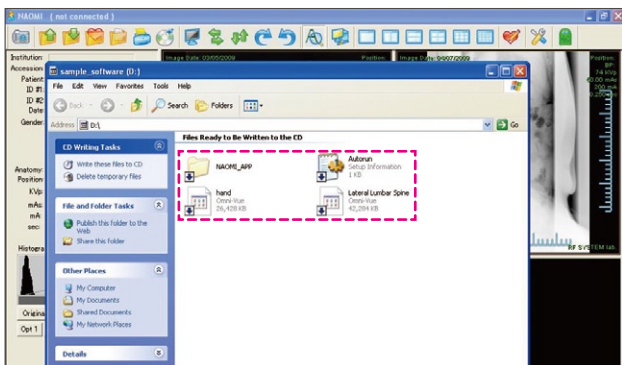

4. If you select two images like this instruction shows you, the both files will be ready to be burned on a CD with the NAOMI.app folder that contains NAOMI VIEWER software program.



5. When a blank CD is inserted, Writing Wizard appears on your screen. Type in the CD name as you wish. Then click Next.

NOTE

When CD Writing Wizard does not appear automatically, click on "Write these files to CD" in the CD drive window.

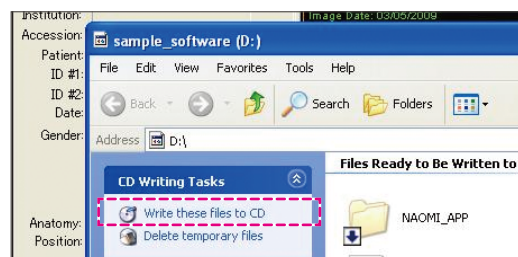

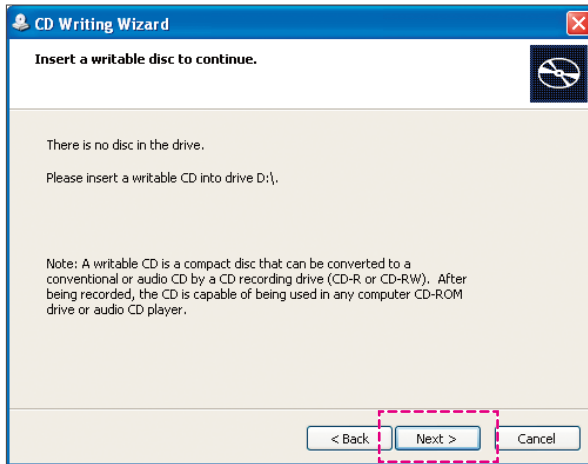

6. Follow the wizard by clicking “Next”. Once the writing process finishes, the CD or DVD is ejected automatically from your computer.

How to burn x-ray images on to a CD-ROM (Windows 7&8)

**CD Burn Icon
(Windows 7&8)**



Click on the CD icon.

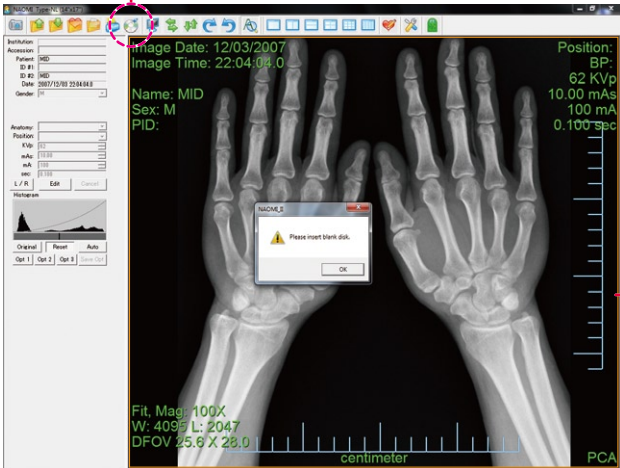

1. Display the image(s) you would like to burn on the CD-ROM. Make sure the image is selected (shown with the orange frame), then, click on CD icon.

Orange frame shows you the image you have selected.

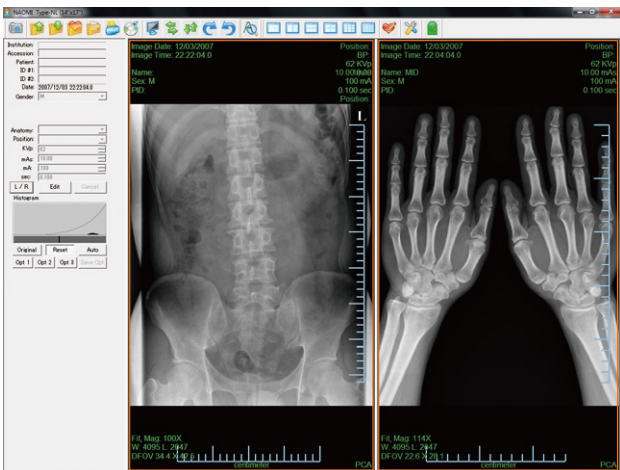

! POINT

To burn multiple images, you select more than one images you want to burn on CD. Make sure that images you want to have on CD are selected and with the orange frame.

NOTE

Press and hold **Ctrl** key then select two or more images to have multiple selection.

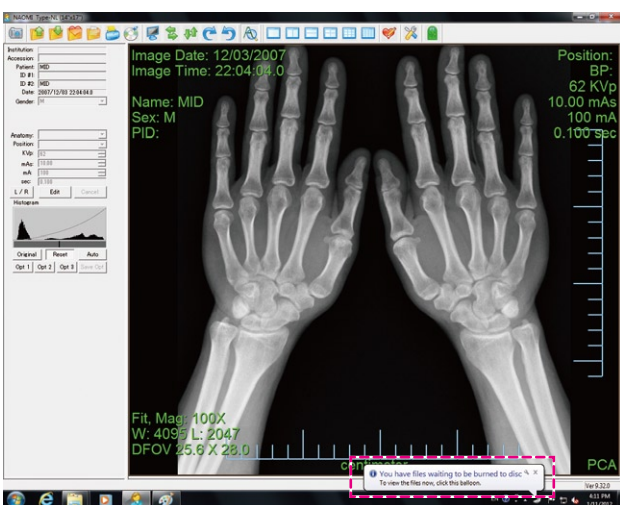

2. The software automatically prepare the selected image(s) together with the NAOMI.app folder (viewer software program).

How to burn x-ray images on to a CD-ROM (Windows 7&8)

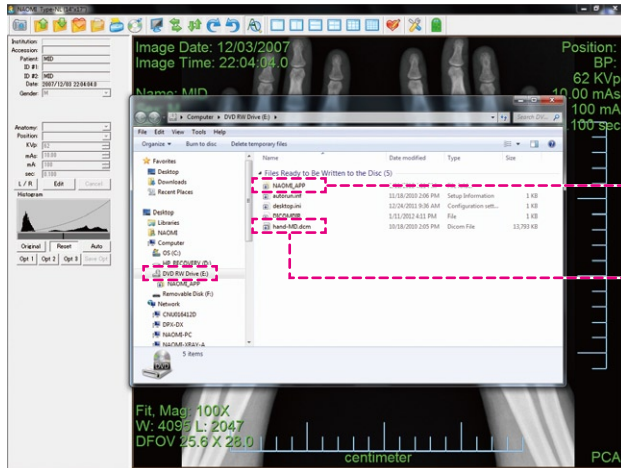

3. Insert a blank CD or DVD. These files are ready to be burned onto a blank CD. Click "Write these files to CD" to burn a CD.

This folder contains the NAOMI VIEWER software program.

The image file you have selected.

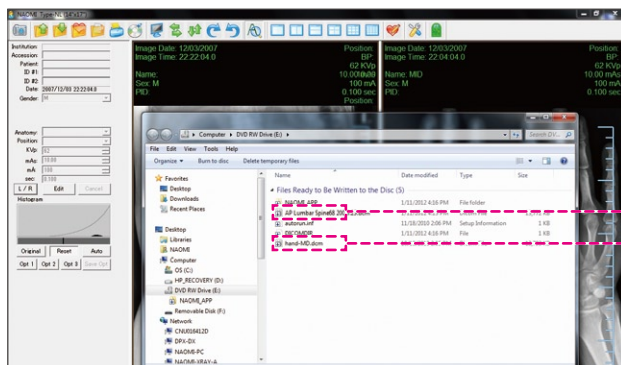

4. If you select two images like this instruction shows you, the both files will be ready to be burned on a CD with the NAOMI.app folder that contains NAOMI VIEWER software program.

The image files you have selected.

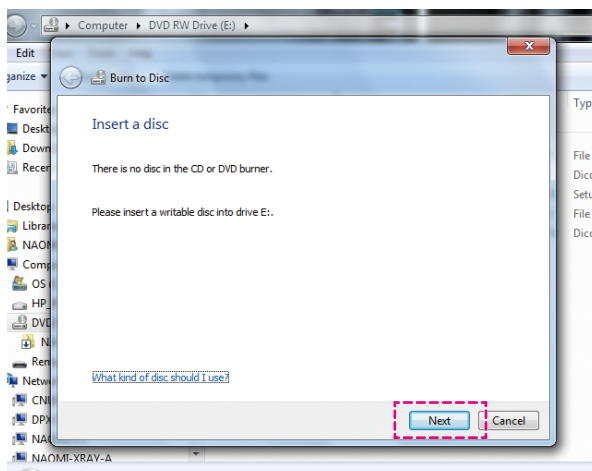

5. When a blank CD is inserted, Writing Wizard appears on your screen. Type in the CD name as you wish. Then click Next.

NOTE

When CD Writing Wizard does not appear automatically, click on "Write these files to CD" in the CD drive window.

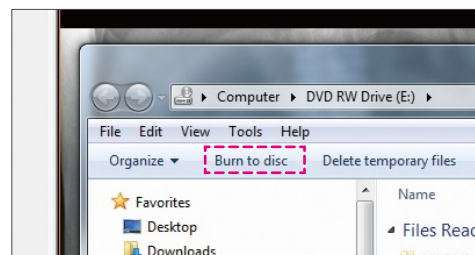

How to burn x-ray images on to a CD-ROM (Windows 7&8)

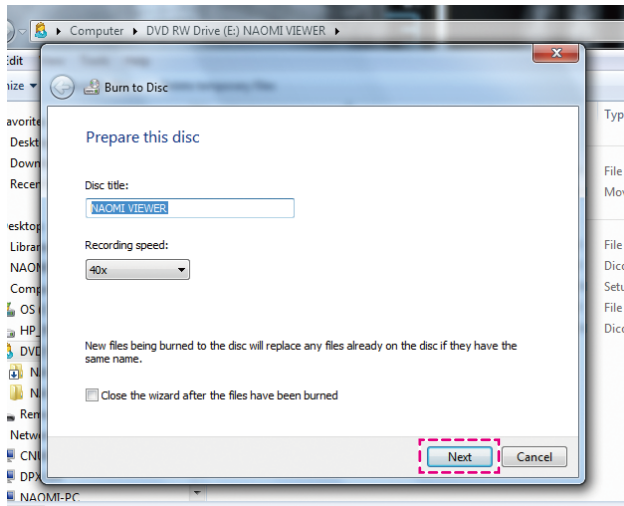

6. Follow the wizard by clicking “Next”. Once the writing process finishes, the CD or DVD is ejected automatically from your computer.

16 How to Reverse Negative / Positive

Negative / Positive Change Over Icon

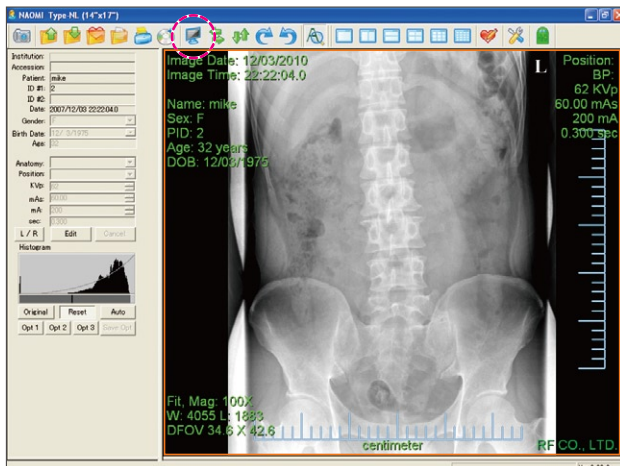

1. Select the image you wish to reverse negative / positive.
Click the Negative / Positive Change Over icon.

NOTE

The selected image is highlighted in orange.

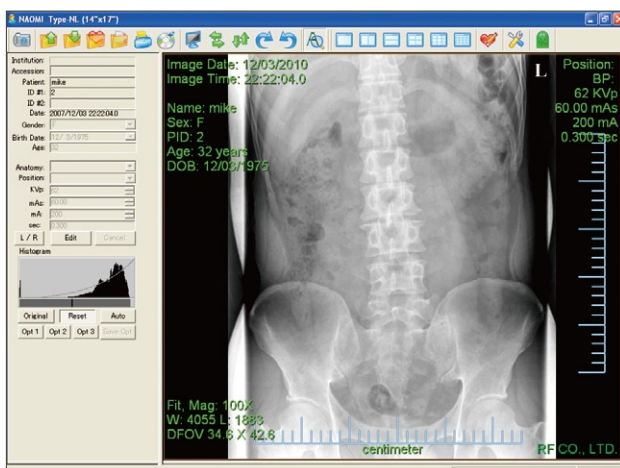

2. Each time you click the Negative / Positive Change Over icon, it switches between Negative and Positive on the image.

Negative

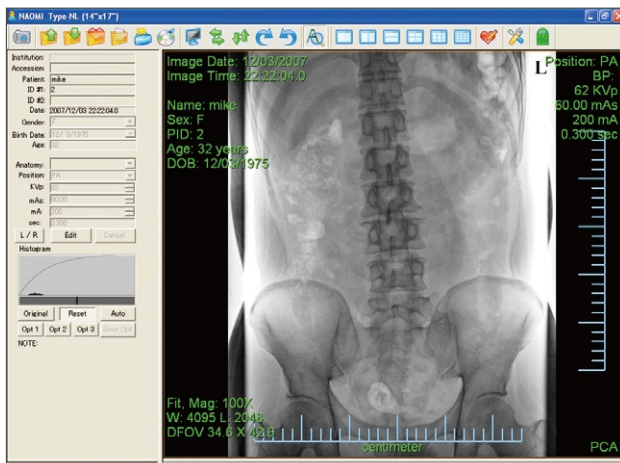

Positive

17 How to Invert the Selected Image

Reflection Icon (Horizontal)

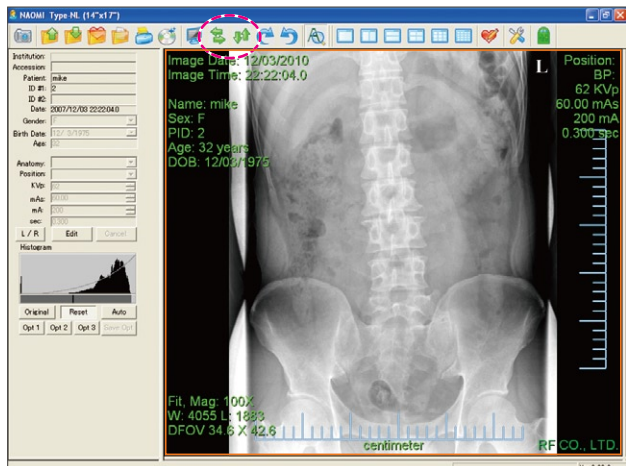

1. Select the image you wish to change its direction.
Click the Reflection icon (Horizontal).

NOTE

The selected image is highlighted in orange.

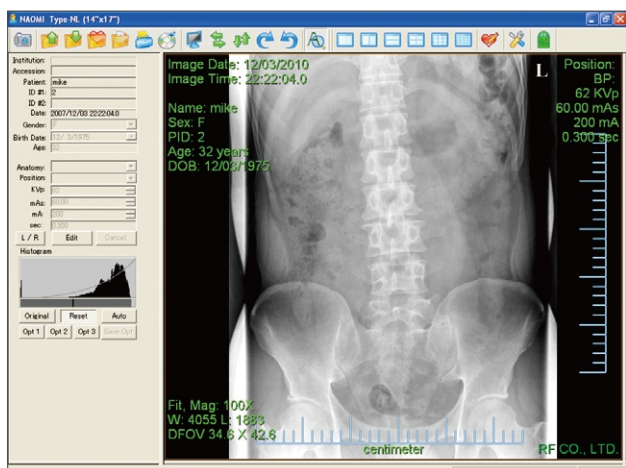

2. Each time you click the Reflection icon (Horizontal), it switches its direction horizontally.

NOTE

To change vertically, press the Reflection icon (vertical) .

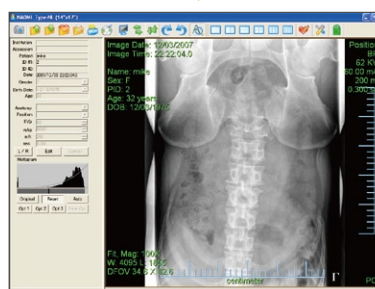
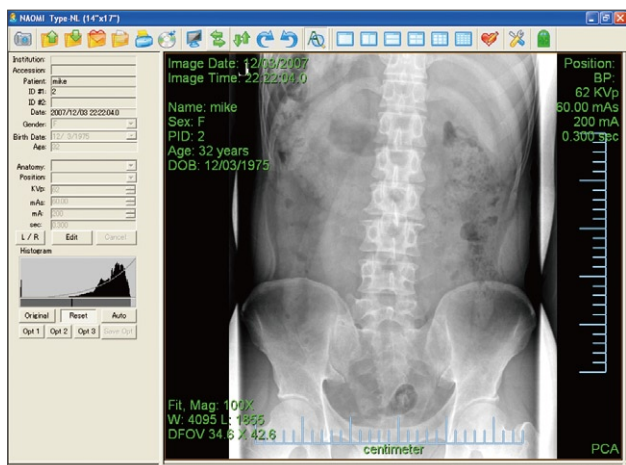
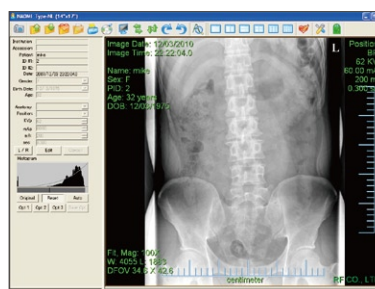

Rotation Icon (Clockwise)

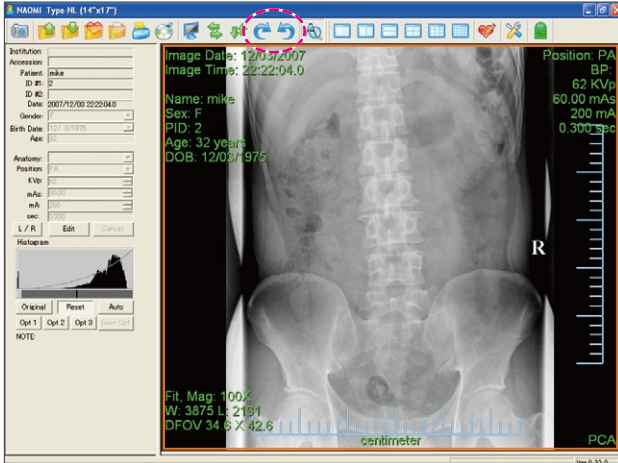

1. Select the image you wish to rotate in clockwise direction. Click the Rotation icon (Clockwise).

NOTE

The selected image is highlighted in orange.

2. Each time you click the Rotation icon (Clockwise), it rotates the image clockwise in every 90 degrees.

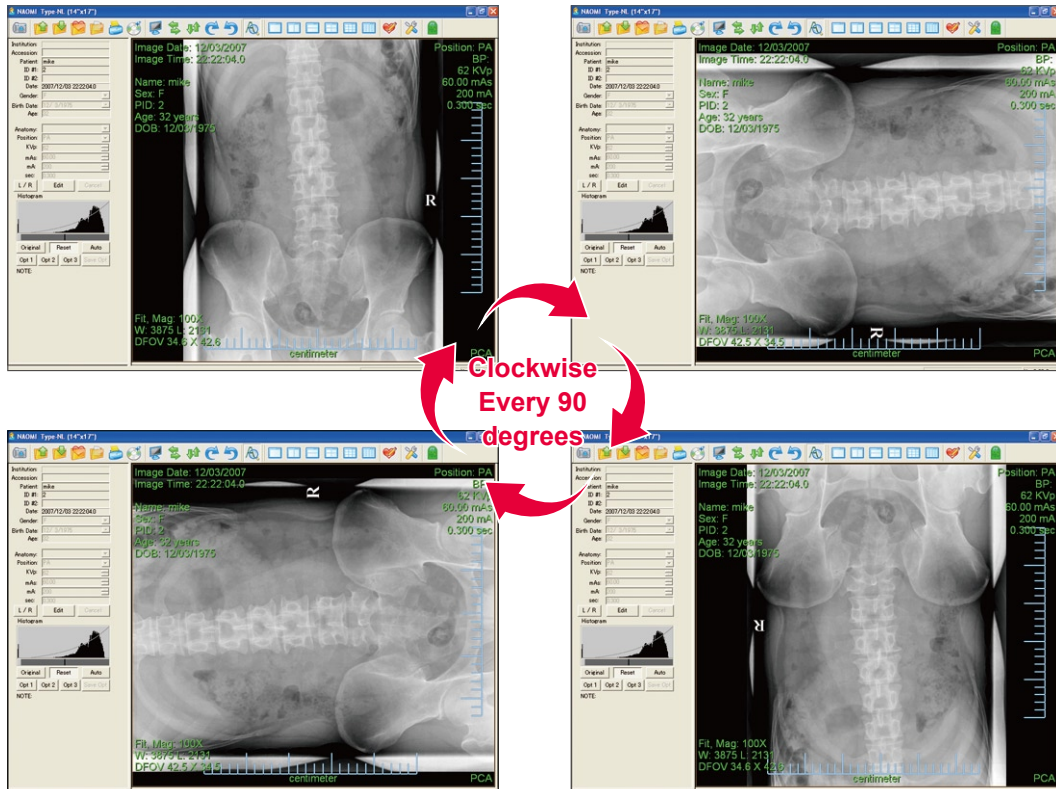

NOTE

The image can be rotated counterclockwise by pressing Rotation Icon (counterclockwise)



19 How to Turn On/Off the Enhancement

Enhancement Icon

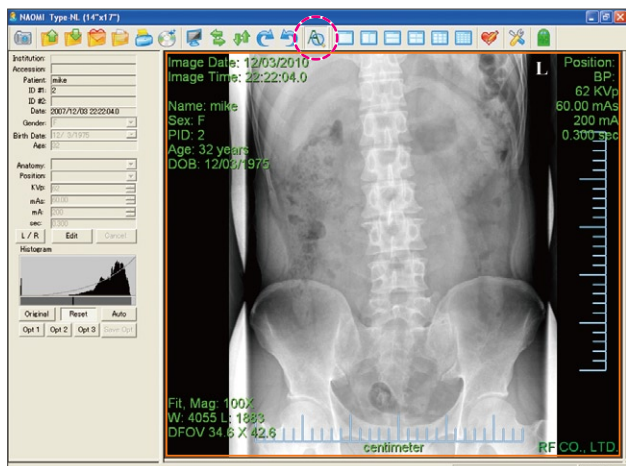

1. Select the image you wish to change its sharpness.
Click the Enhancement icon.

NOTE

The selected image is highlighted in orange.

Normal : Standard Sharpness (Unsharp Mask)

MSE : Multi-Scale Enhancement

(Recommended)

(Refer to page Software -55 for the enhancement setting.)

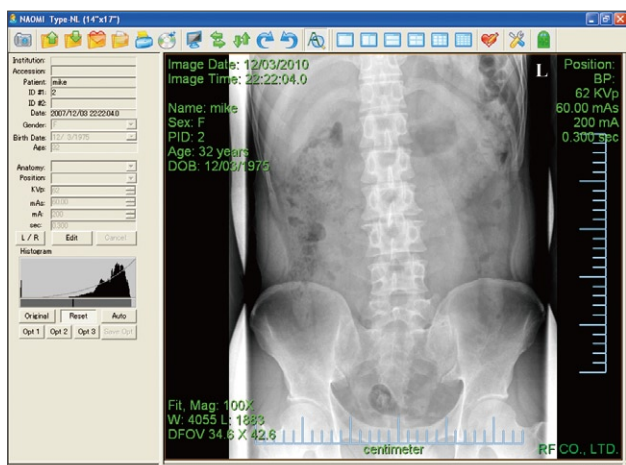

2. Each time you click the Enhancement icon, it changes the sharpness of the selected image.

NOTE

The sharpness level is adjustable in Setup Menu.

Refer to "How to Change the Setting" (Page: Software - 52).

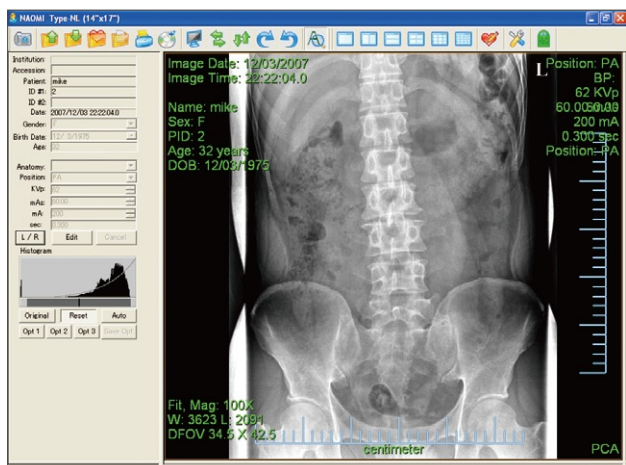

NOTE

You can activate the sharpness function for every image you capture by changing the settings.

Refer to **3 Effect** on Page Software - 55 for details.

Display Window Icon

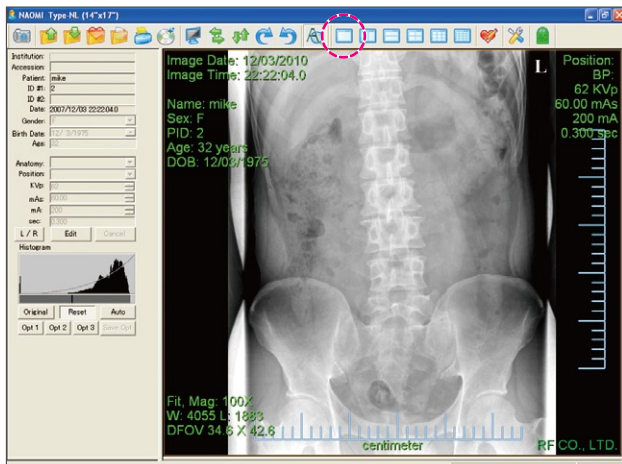

1. Click the Single Window icon.

NOTE

If you wish to display multiple images at the same time on the screen, refer to
 2 images : Double Window
 4 images : Quarter Window
 9 images : 3 x 3 Window
 16 images : 4 x 4 Window
 Press the Single Window icon to return to the single window from the multiple image display.

[2 x 1 Horizontal]

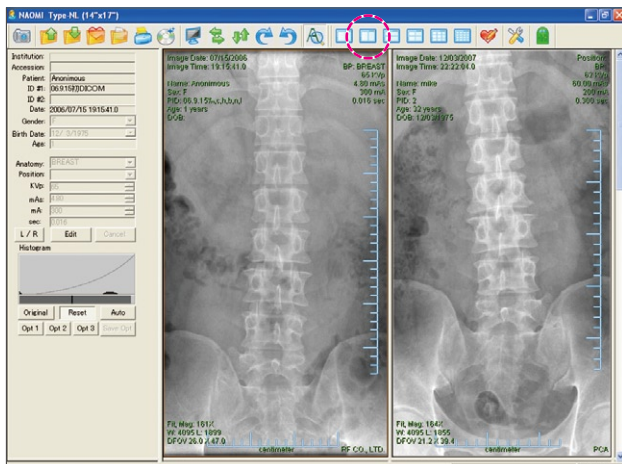

2. Click two Images together Window to display (Vertical) appears.

NOTE

- ⦿ The selected image is highlighted in orange.
- ⦿ You may capture or open new images. A new image appears in the top left window, and other images are moved by one block.
- ⦿ Double click an image to display in single window.

[1 x 2 Horizontal]

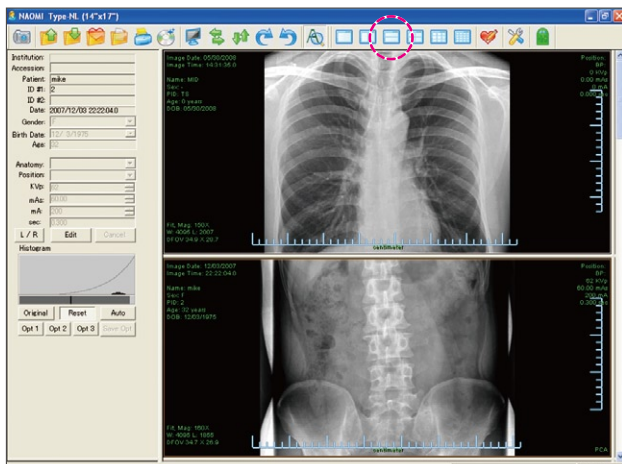

NOTE

To display two images horizontally, press the Double Window icon (horizontal).

How to Change the Display Mode on Screen

[2 x 2]

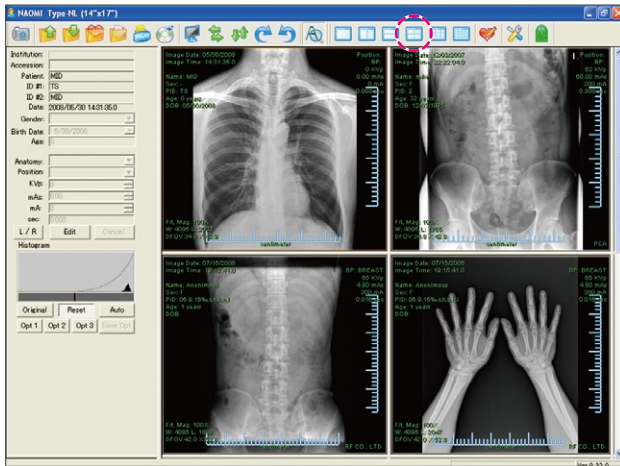



3. Click Quarter Windows Icon to display 4 images together.
You may display up to 4 images.

NOTE

- The selected image is highlighted in orange.
- You may capture or open new images. A new image appears in the top left window, and other images are moved by one block.
- Double click an image to display in single window.



NOTE

To display 3x3 or 4x4, press 3x3 Window icon  or 4x4 Window icon. 

To display the desired images in a different view, select them by pressing **ctrl** key on the keyboard. then click on double window icon  or quarter window icon  to display.

[4 x 4]

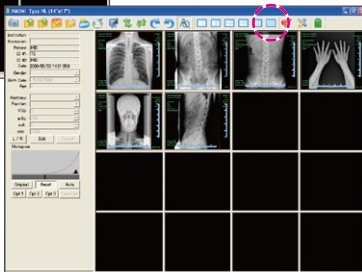

21 How to Open / Close Annotation Menu

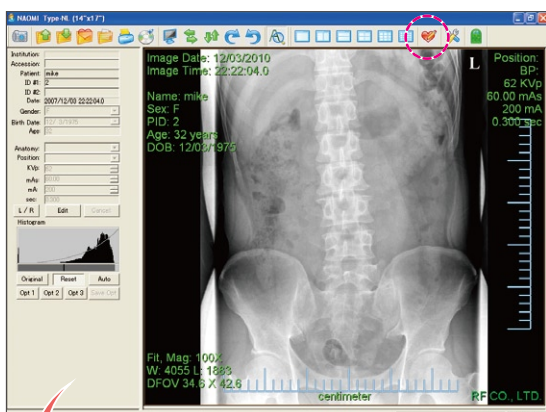

Annotation Icon



To Open

Click  icon.

NOTE

The annotation window has functions to insert text, shapes, and lines or to measure the specific areas on the x-ray images.

The annotation window opens.

Click  icon to open the image file you wish to put the annotation.

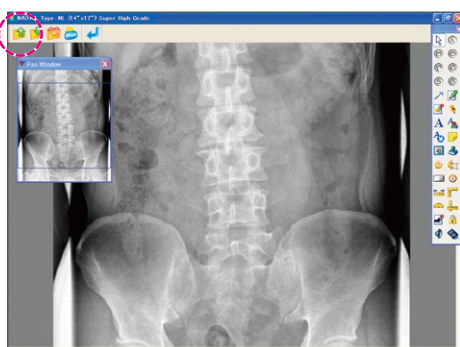



To Close

Click  icon.

NOTE

The annotation window closes.
Annotations will not be saved automatically.

To save annotations, click on () to save the annotations. It is saved as “.ann” file format. To view the annotations on the image, open the image by ().

NOTE

To save annotated image in a different format to view in a viewer software, click () to save. By saving in a different format (ex. JPEG), the annotated image can be display in a viewer software.

NOTE

The window goes back to the main screen.

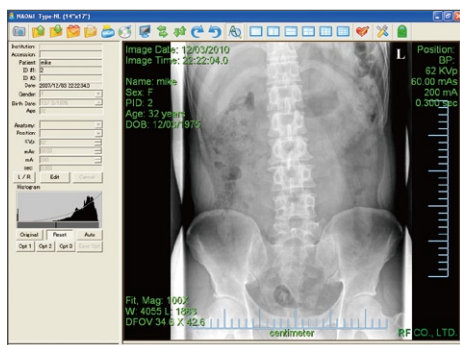
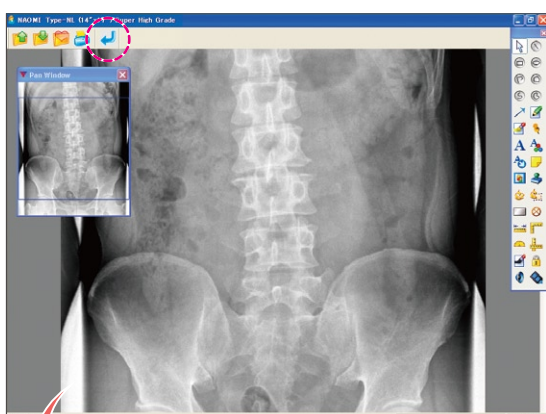



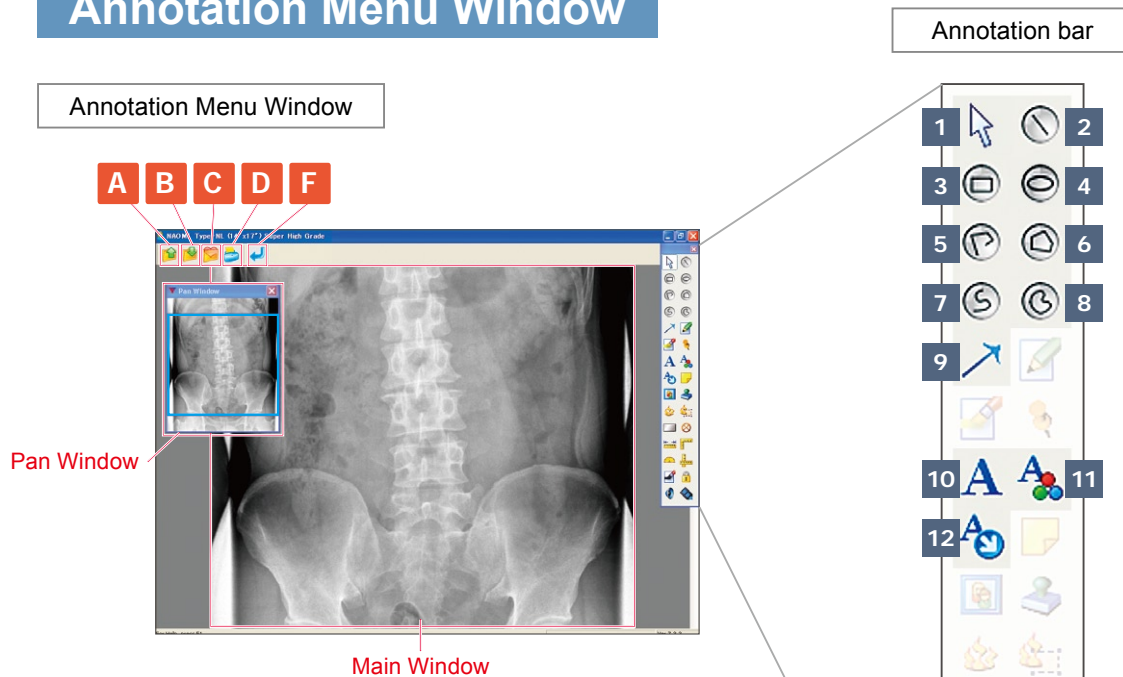

22 Annotation Menu

Annotation Menu Window



Annotation Menu Icon

- A:**  **Open Icon** : To open the image file.
(Software-41)
- B:**  **Save Icon** : Save the annotated image
- C:**  **Overwrite Icon**: Overwrite the annotation on the originally saved image.
- D:**  **Print Icon** : Print the annotated image
- E:**  **Close Icon**: To close the annotation menu.
(Software-41)

Annotation Bar Icon

- | | | |
|------------------------------------|----------------------------------|-----------------------------------|
| 1 Selection Pointer | 2 Line Annotation | 3 Rectangle Annotation |
| 4 Ellipse Annotation | 5 Polyline Annotation | 6 Polygon Annotation |
| 7 Curve Annotation | 8 Closed Curve Annotation | 9 Pointer Annotation |
| 10 Plain Annotation | 11 Rich Text Annotation | 12 Text Pointer Annotation |
| 13 Ruler Annotation | 14 Polyruler Annotation | 15 Protractor Annotation |
| 16 Cross Product Annotation | | |

Pan Window (Navigation Window)

The pan window is the navigation window, which shows where the main window is focusing on the displayed image. It helps to avoid the orientation especially when the displayed image is highly magnified.

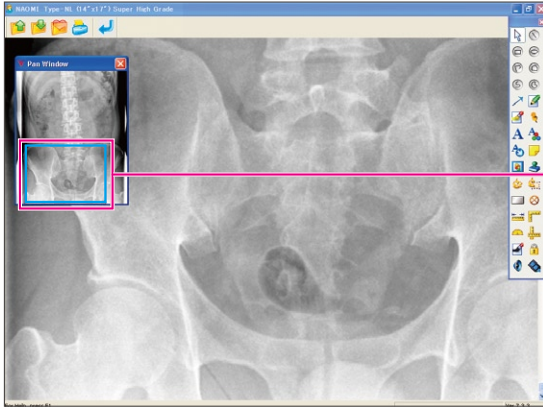

Navigate

Click and drag the **blue frame** on the pan window to navigate through the displayed image.

As the blue frame is moved in the pan window, the image on the main window changes the displaying area correspondingly.

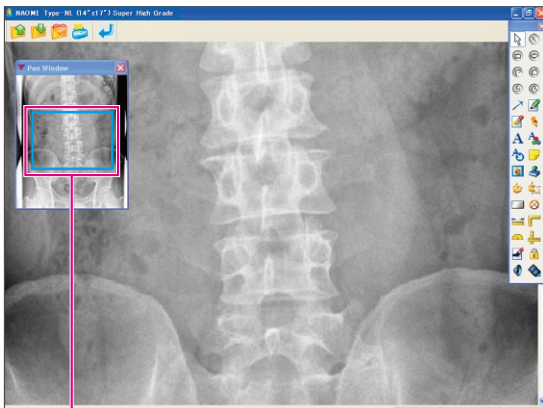

The blue frame becomes smaller when the image is zoomed in.
The blue frame becomes larger when the image is zoomed out.

Zoom In / Out

Press **+** for zoom in or **-** for zoom out.



NOTE

Click on the main window (displayed image) to zoom in/out.

This Section Explains How to...

A Draw a Straight Line / Arrow / Polyline

C Draw a Curved Line / Shape

E Measure the Length

G Select the Annotation Object

B Draw a Shape

D Insert the Text or Note

F Measure the Angle

A Draw a Straight Line / Arrow / Polyline

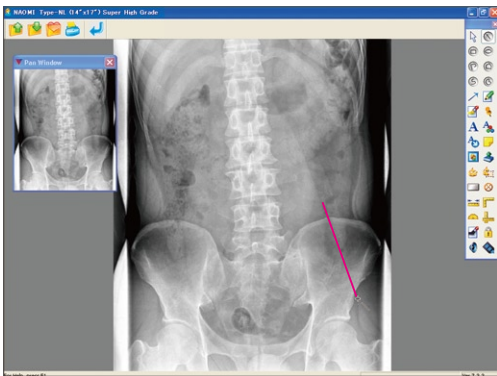
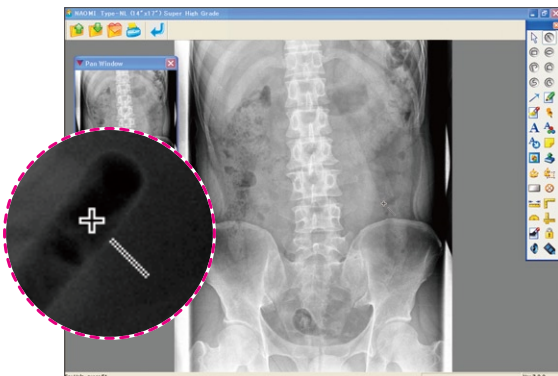

Straight Line

Click  icon.

The cursor changes to .

Click left button on the mouse and drag to draw a straight line.

NOTE

Hold **shift** key to draw a straight line in 45 degrees angle.
Release the left mouse button to complete the line.

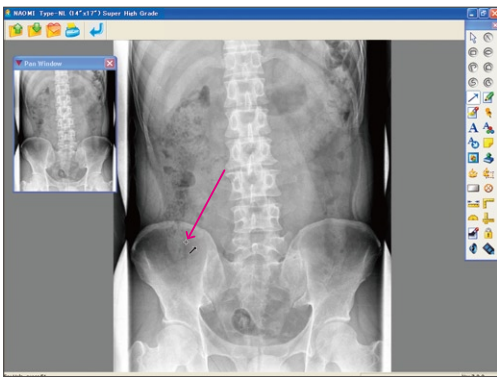
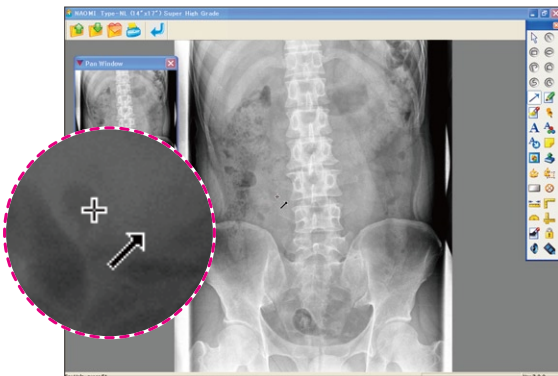

Arrow

Click  icon.

The cursor changes to .

Click and drag to draw an arrow.

The starting point becomes the pointed end of the drawn arrow.

Release the left mouse button to complete the arrow.

NOTE

Hold **shift** key to draw an arrow in 45 degrees.

Draw a Straight Line / Arrow / Polyline

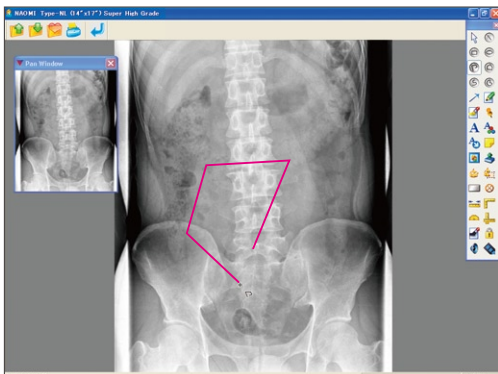
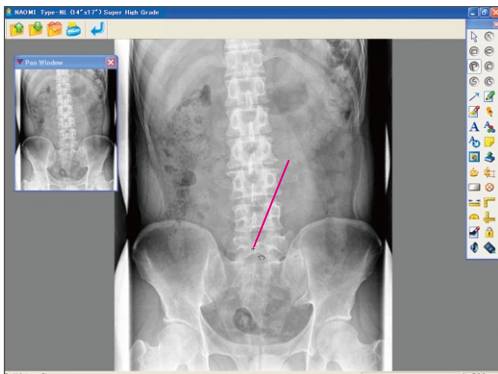
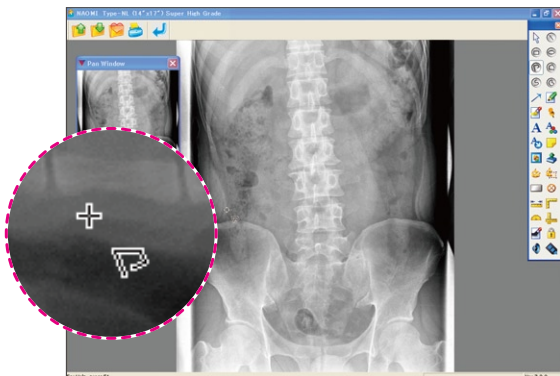

Polyline

The polyline is an array of points with a sequence of joined lines.

Click  icon.

The cursor changes to 

Click and drag to draw the first line.

Click again to create another line.

NOTE

Repeat until the desired number of points and lines are achieved.

Double click to complete.

B Draw a Shape

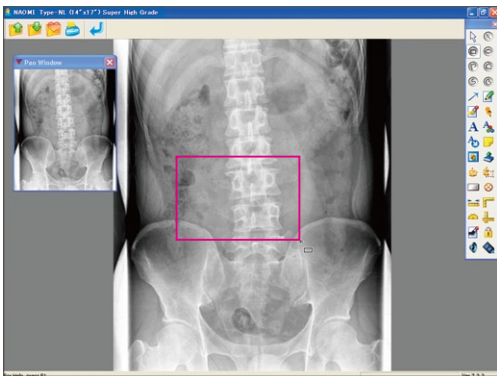
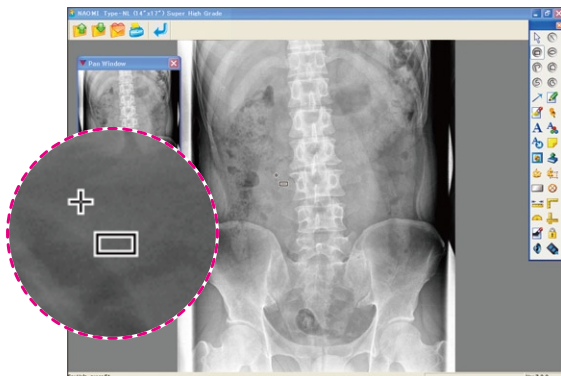

Rectangle

Click  icon

The cursor changes to 

Click and drag to draw a rectangle.

NOTE

Hold  key to draw a square.

Release the left mouse button to complete.

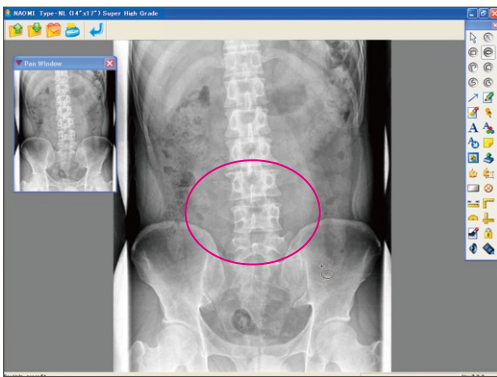
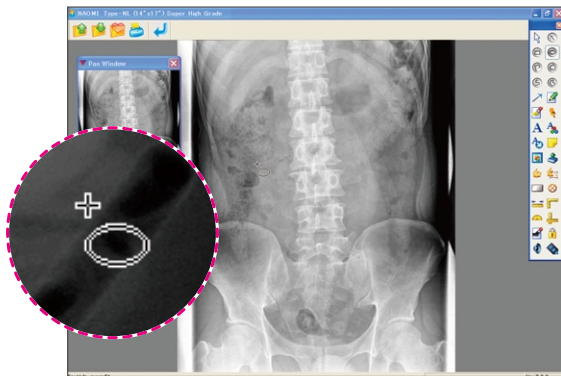

Ellipse

Click  icon.

The cursor changes to 

Click and drag to draw an ellipse.

NOTE

Hold  key to draw a circle.

Release the left mouse button to complete.

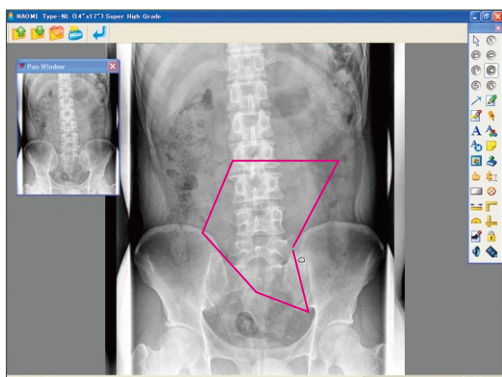
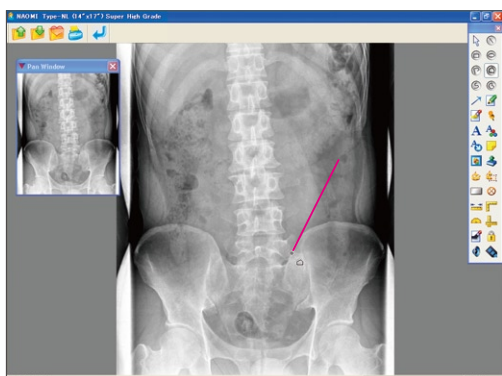
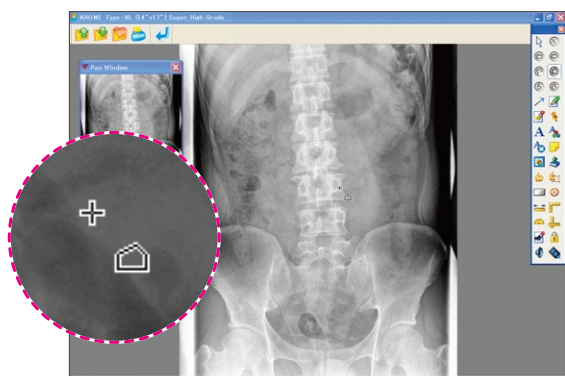

Polygon

The polygon is an array of points with the vertices of a polygon.

Click  icon.

The cursor changes to 

Click and drag to draw the first line.

Click again to create another line.

NOTE

Repeat until the desired number of points and lines are achieved.

Double click to close the shape you have drawn.

C

Draw a Curved Line / Shape

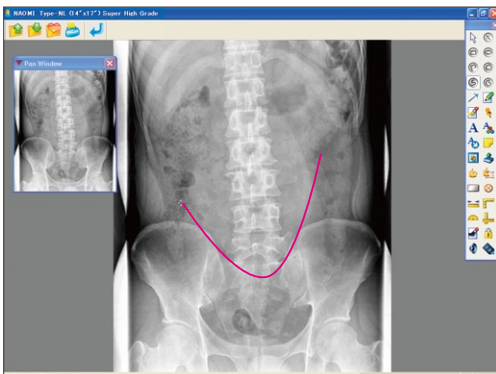
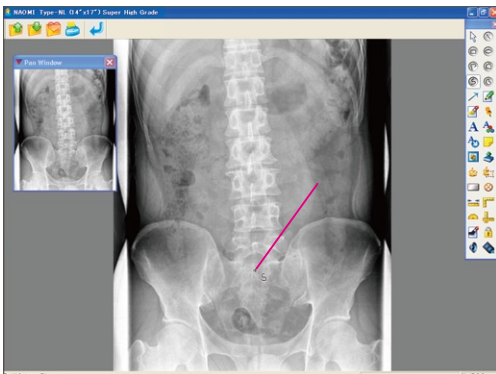
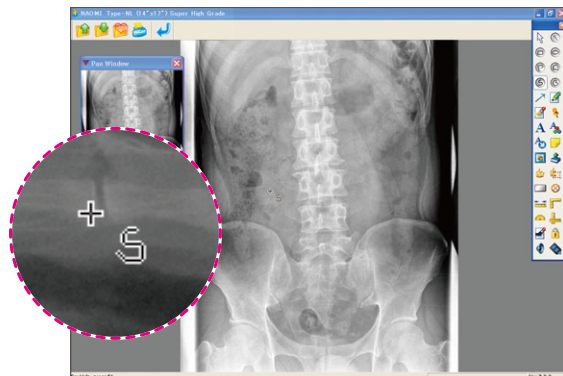

Curved Line

Click  icon.

The cursor changed to 

Click and drag to draw the first line.

Click again to create first curving point and drag to change the degree of curve.

NOTE

Repeat until the desired number of points and lines are achieved.

Double click to complete.

Draw a Curved Line / Shape

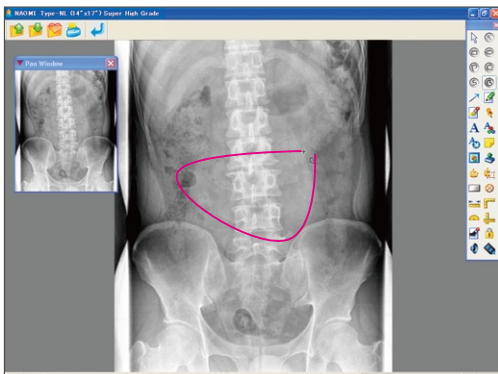
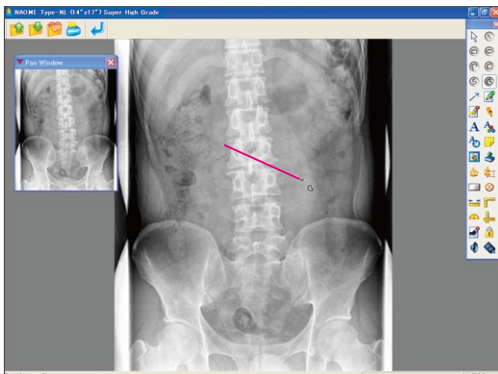
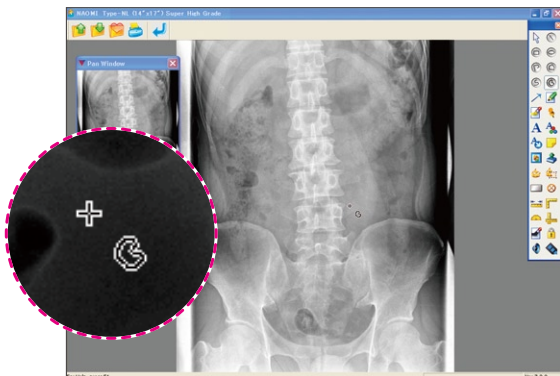

Curved Shape

Click  icon.

The cursor changed to 

Click and drag to draw the first line.

Click again to create first curving point and drag to change the degree of curve.

NOTE



Repeat until the desired number of points and lines are achieved.

Double click to close the shape you have drawn.

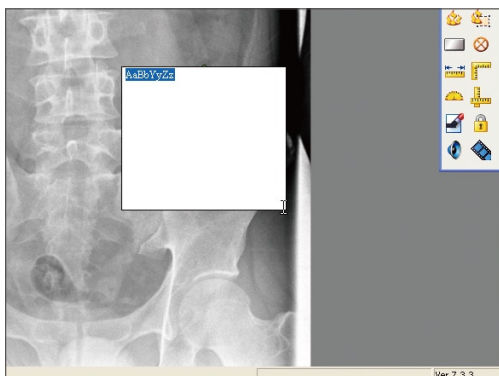
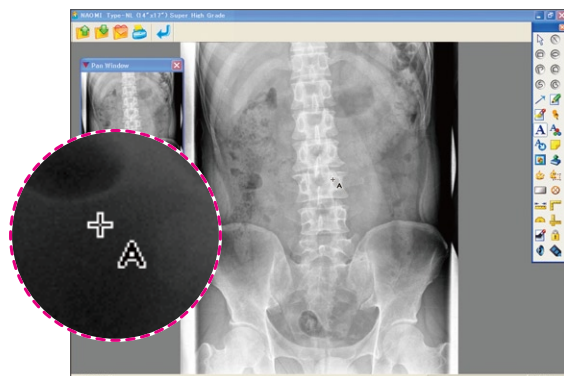
D Insert the Text or Note



Plain / Rich Text

Click  for Plain Text or  for Rich Text.

The cursor changes to  .

Click and drag to create the text box.

The text box appears on the screen. Type the note in the text box.

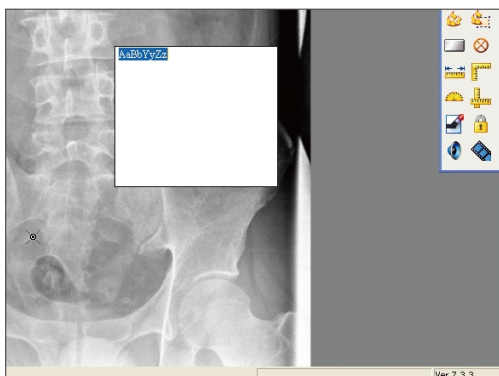
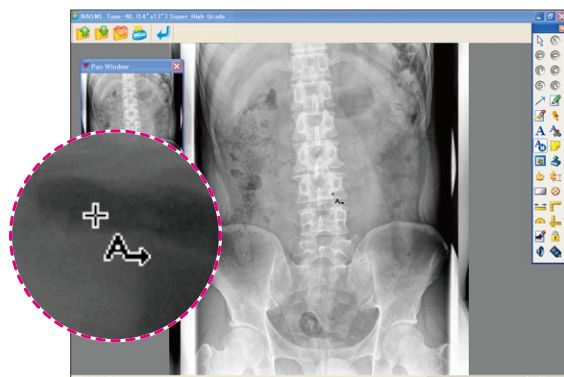

Text Pointer

Click  icon.

The cursor changes to .

Click and drag to create the text box. Once the text box is drawn, drag the cursor to create the pointer to desired location.

The text box with an arrow appears on the screen. Type the note in the text box.

E Measure the Length

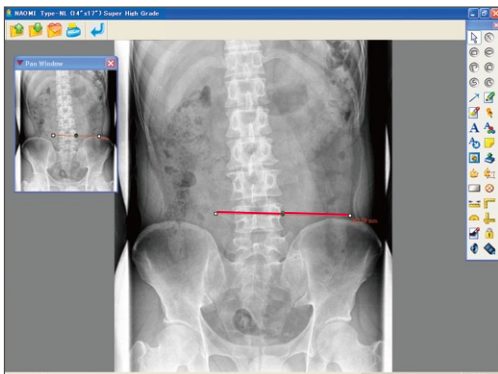
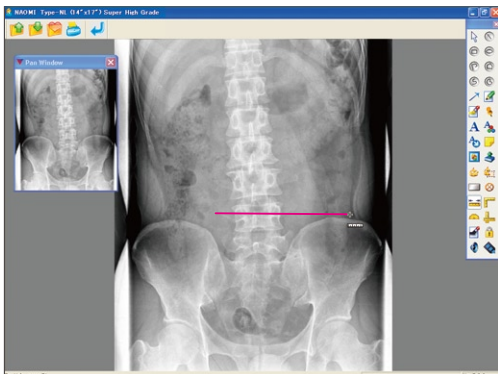
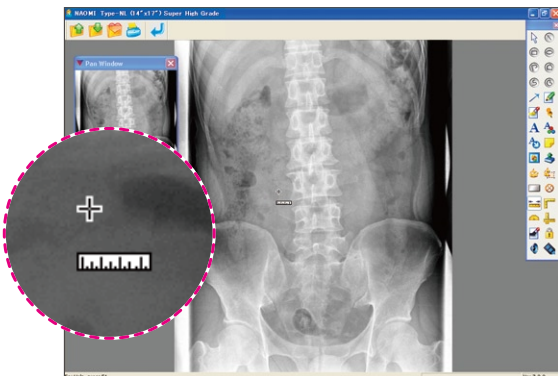

Ruler

Click    to measure.

The cursor changes to   

Click and drag to draw the desired ruler.

The length appears on the screen.

NOTE

The length unit can be changed on the ruler property. To open the property, right click the image screen and select Ruler Property.

Select Ruler to open the ruler property.

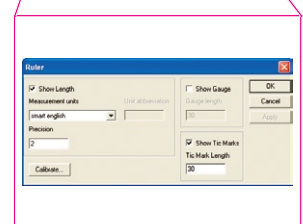
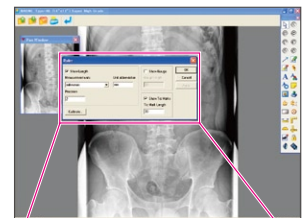
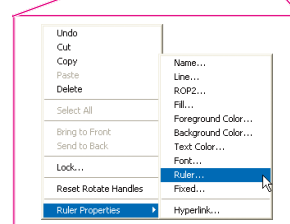
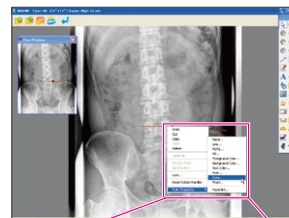

F Measure the Angle

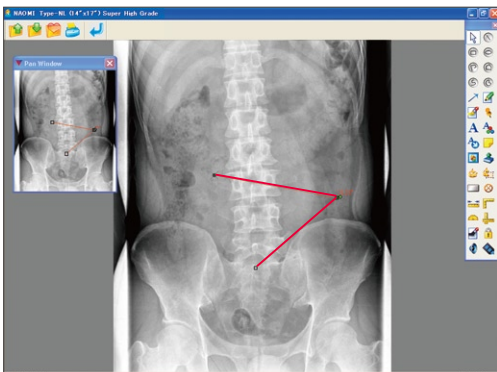
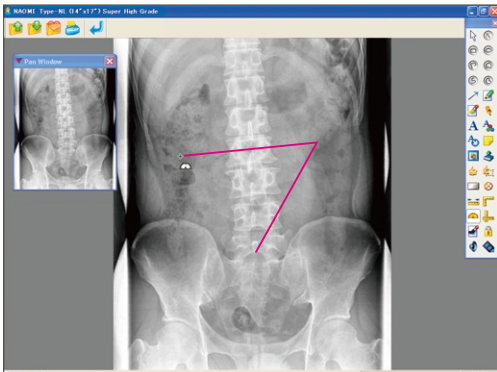
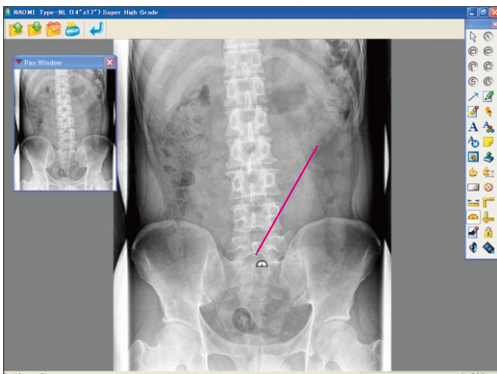
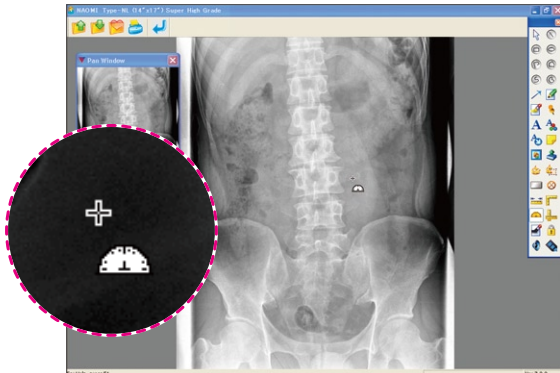

Protractor

Click  icon.

The cursor changes to 

Click and drag to draw an first line.

NOTE

This line becomes an anchor.

Click again and move the cursor to create the desired degree of angle.

Click again to complete.

G Select the Annotation Object

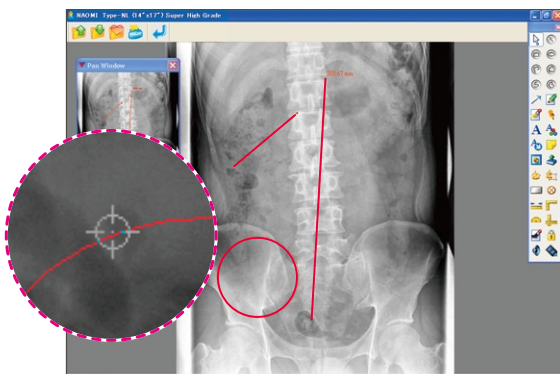

To Select

Click  icon.

Place the cursor over the object.

The cursor changes to 

Click on the object to select.

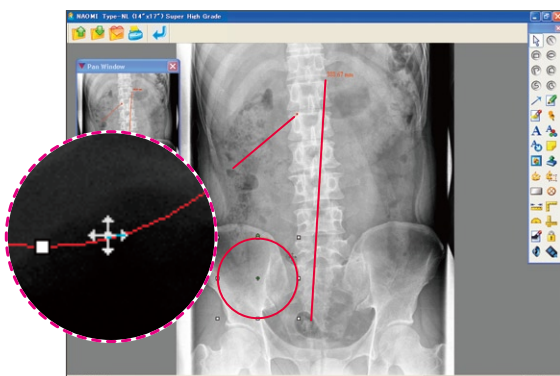

To Move

Place the cursor over the selected object. The cursor

changes to 

Click and drag to move the object location.

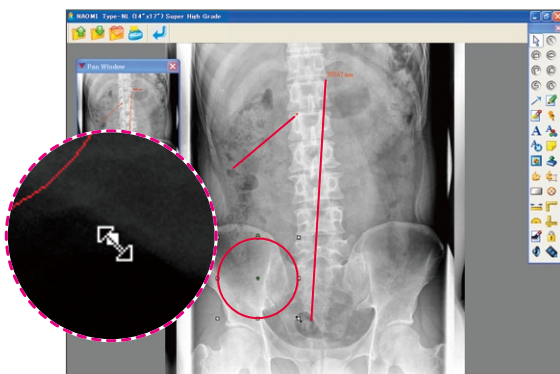

To Resize

The selected object shows a white small dot on each corner or each end of the line.

Place the cursor over the white dot.

The cursor changes to 

Click and drag to resize the object.

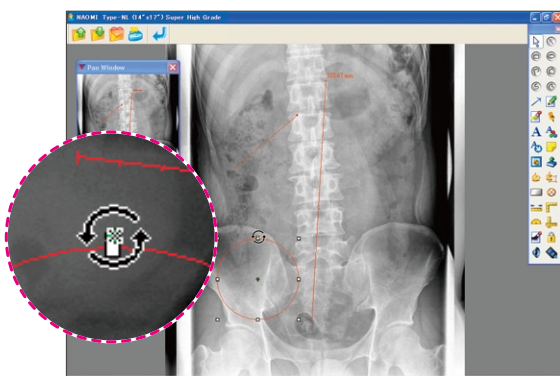

To Rotate

The selected object shows two green circles. One green circle is to show the center of the object. The other green circle is to show the anchor point of the rotation.

Place the cursor over the green circle. (Anchor point)

The cursor changes to 

Click and drag to rotate the object.

23 How to Change the Setting

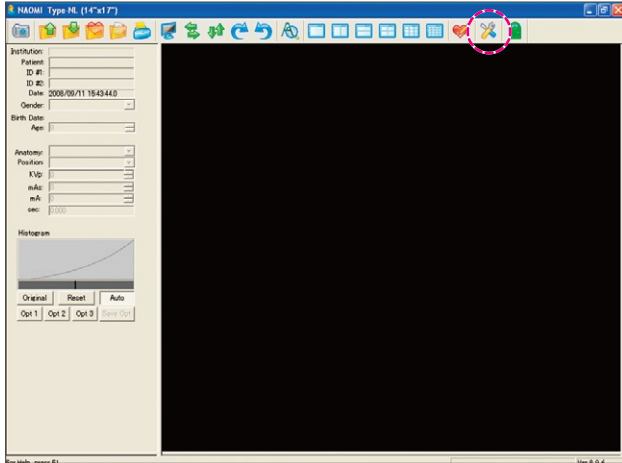

Click the Setup icon.

General Tab

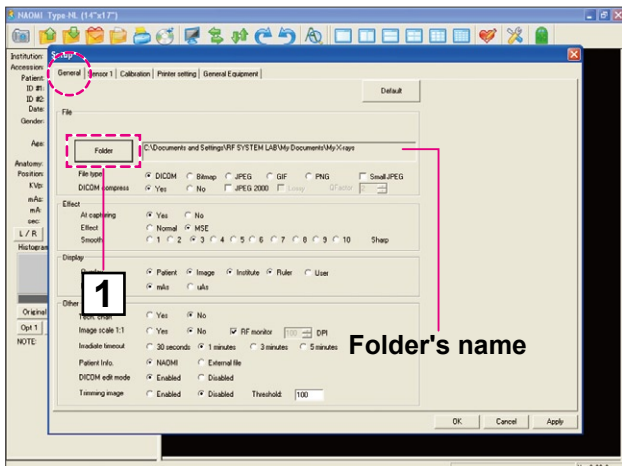

1 Folder

You can change the location of folder to save images.

Click "Folder" to select the saving location.

The image will be automatically saved in the selected folder.

NOTE

Refer to "Before Capturing the X-Ray..." on page Software - 05.

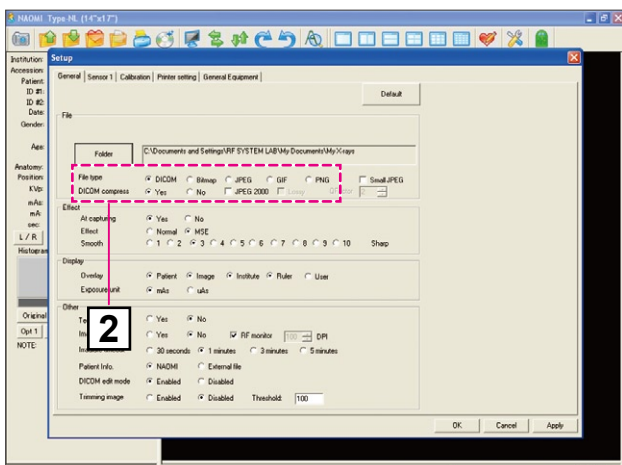

2 File Type

- DICOM DICOM Format (standard)
- DICOM DICOM Format (compressed)
- Bitmap BMP Format
- JPEG JPEG Format
- GIF GIF Format
- PNG PNG Format (for Mac. user)
- Small JPEG JPEG Format (compressed)

NOTE

This is to set the default file format, which the captured images are automatically stored as.

By selecting multiple file format types, the software will save the images as selected file formats.

How to Change the Setting

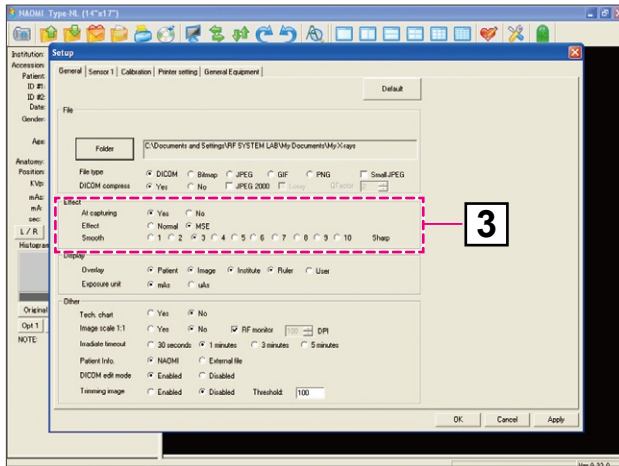

3 Effect (Enhancement)

This is for Enhancement Function. You can activate / deactivate by clicking  icon on the main menu.

At capturing

"Yes": automatically activate the enhancement function for every captured image. (Default Setting)

"No": deactivate the enhancement function at the time of capturing.

Effect

The selected image is highlighted in orange.

Normal : Standard Sharpness(Unsharp Mask)

MSE : Multi-Scale Enhancement
(Recommended,default)

Smooth - Strong

The level of the enhancement. Select the Enhancement effect level (1 to 10), and click OK. "1" is the minimum, "10" is the maximum level of the enhancement function.

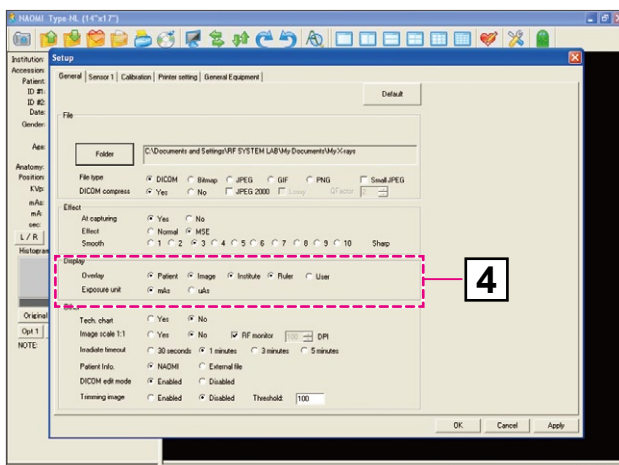

4 Display

The orientation of the displayed image. You may change the orientation of the captured image to be displayed on the NAOMI software.

Overlay

By clicking each check box on Patient, Image, Institute, Ruler and User can select the information to be displayed on the image.

Exposure unit

The exposure can be entered in mAs or uAs by checking on the check box.

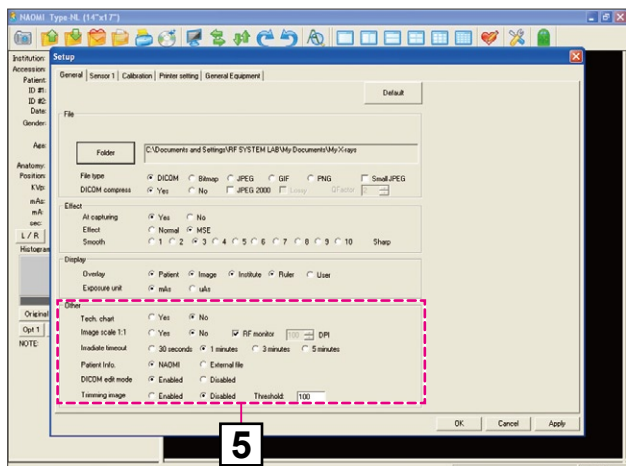

5 Other

Tech Chart

Yes: To activate the exposure technique chart menu when capturing x-ray images. The Tech. Chart button appears on the Select / Register ID menu.

No: To deactivate the exposure technique chart menu when capturing x-ray images. It hides the Tech. Chart button on the Select/Register ID menu.

Image scale 1:1

Yes: To display the x-ray image in actual size (full-scale). Enter the DPI value corresponding to your monitor's resolution (ex. from 85 to 86 DPI for a 19-inch monitor). When you are using RF High-Contrast Monochrome Monitor, check on the check box of "RF monitor".

No: To display the x-ray image in the fit-to-window size.

Irradiate timeout

The timeout period after the message, "Please irradiate x-ray" appears, can be selected from 30 seconds to 5 minutes.

Patient Info

NAOMI: The patient information list is created and opened from the NAOMI software.

External file: The patient information list is created by a different software (i.e. Electronic Medical Record), and imported into the NAOMI software.

DICOM Edit Mode

It enables to revise the patient information and x-ray technique records after capturing the image. Refer to Software - 21 for details.

Trimming Image

This allows to cut off the collimation area (where the x-ray is not exposing) from the image you are capturing. Only effective when capturing an x-ray image. This cannot erase off the collimation area after taking the image. The value refers a difference of a brightness and darkness. Default setting is 100.

How to Change the Setting

Sensor 1 Tab

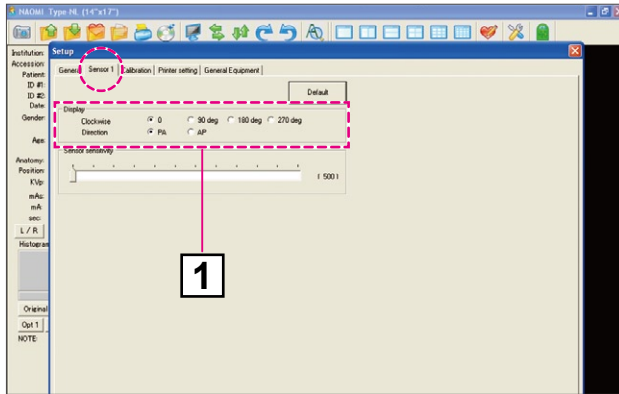

1 Display

The orientation of the displayed image. You may change the orientation of the captured image to be displayed on the NAOMI software.

Clockwise

To display the captured image by rotating 0, 90, 180, 270 degrees.

Direction

To display the captured image from different directions as following.

Irradiation Area



Example



PA



AP

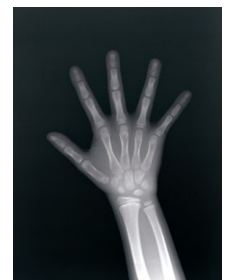

Calibration Tab

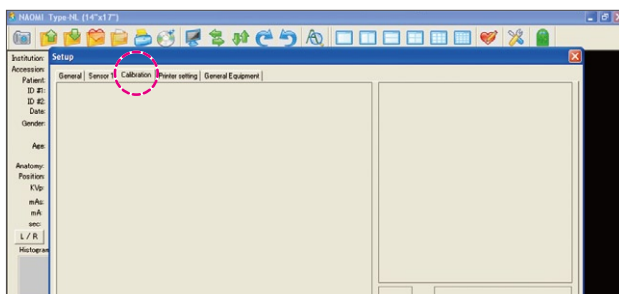

Calibration is only for maintenance. Refer to the QAP (Calibration) section in User's Guide.

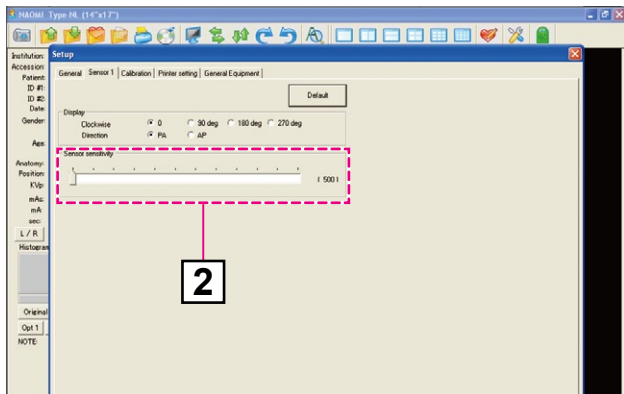

- 2 Sensor sensitivity**
This is only for maintenance.
The default sensitivity is 500.

Printer Setting Tab

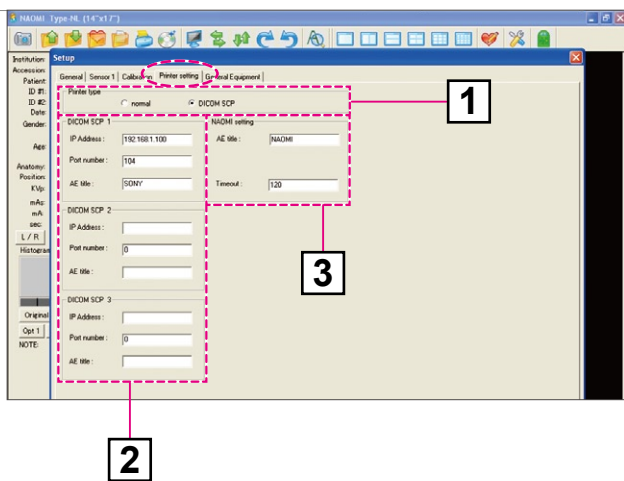

- 1 Printer Type**
Normal Printer -Select "normal".
DICOM Printer -Select "DICOM SCP".
- 2 DICOM SCP Setting**
Only available when "DICOM SCP" is selected. Enter your DICOM printer's information.
- 3 NAOMI Setting**
Only available when "DICOM SCP" is selected.

NOTE

DICOM printer settings can be registered up to 3 printers' information.

General Equipment Tab

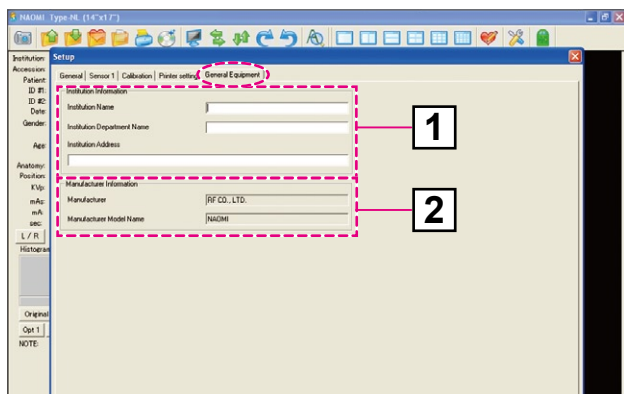

- 1 Institution Information**
Enter your office information. This information will be saved with the images as the institution information, when the images are captured.
- 2 Manufacturer information**
It shows the manufacturer's information.

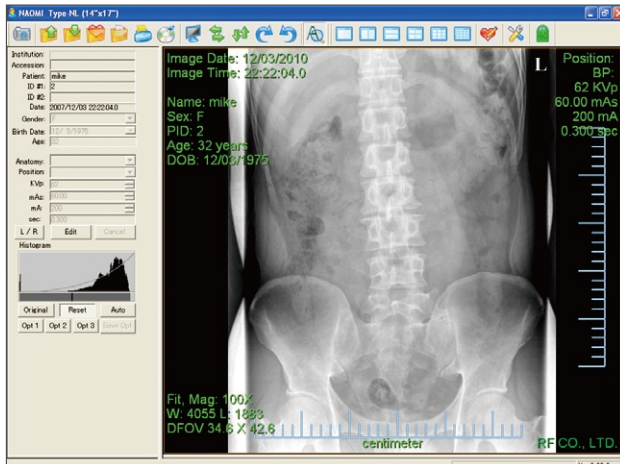
Exit Icon

1. Before you close the NAOMI Software, save the necessary files.

NOTE

Refer to "How to Save the Adjusted Image" (Page: Software - 20).

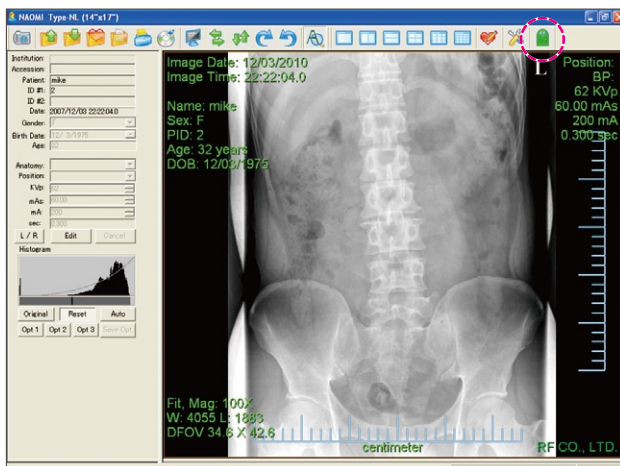

2. Click  icon.

Calibration / QAP (Quality Assurance Program)

QAP (Quality Assurance Program) is the process to correct misalignment and contrast unevenness on each CCD sensor in NAOMI.

There are two calibration processes: Positioning Calibration and Luminance Calibration.

Positioning Calibration

To align each CCD sensor in NAOMI by using the calibration scale. (QAP-02-05)

Luminance Calibration

To adjust each CCD sensor's contrast (brightness level) to create even contrast level on the NAOMI sensor. (QAP-06-10)



NOTE

Both Positioning and Luminance Calibration have been performed prior to the shipment for immediate use. However, in rare cases, there is a possibility of needs to process calibration.



NOTE

Follow the calibration process when....

- You have reinstalled the software to your computer.
- The NAOMI sensor received strong shock.
- There are misalignment in images.



Positioning Calibration
(QAP-02-05)

and

Luminance Calibration
(QAP-06-10)

- There are uneven contrast in images.



Luminance Calibration
(QAP-06-10)



NOTE

RF SYSTEM lab. recommends running a calibration every 12 months for maintenance purpose.



NOTE

If Positioning Calibration is required, Luminance Calibration must be performed after Positioning Calibration is completed.

Please refer to "Confirm the Necessary Calibration Process" to check which calibration process your NAOMI sensor needs.

In this chapter, it explains the following processes.

1: Positioning Calibration (QAP-02-05)

2: Luminance Calibration (QAP-06-10)

This calibration process is to correct the position of each CCD in the NAOMI sensor.
This process must be performed if your image seems similar to **Example Image A** on page : Operation Check-06.

Calibration Scale is required to perform Positioning Calibration.

Set Calibration Scale on the NAOMI sensor securely with Scale Pins.



DO NOT HOLD CALIBRATION SCALE BY EDGES. Calibration Scale contains very sharp edges, and it may cause serious injuries. Handle Calibration Scale with special care. In the case of the injuries caused by Calibration Scale, RF would not assume any responsibility.

🎯 Align to the Left

■ With the NAOMI-2000 series

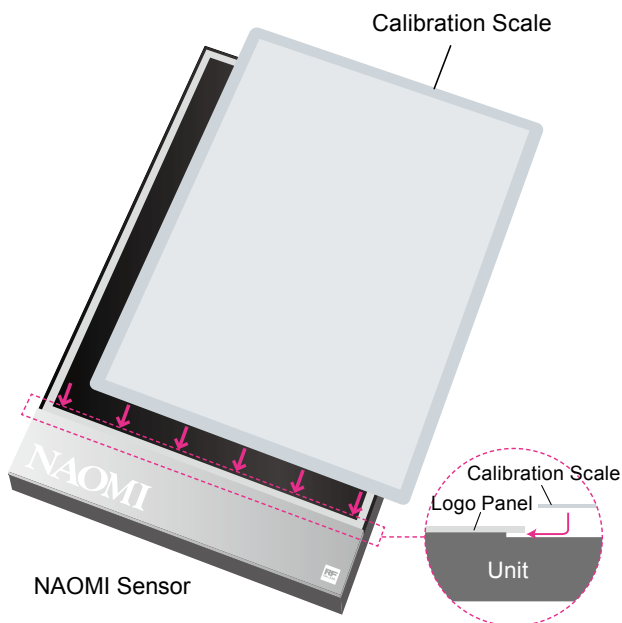

💡 NOTE

Secure the Calibration Scale to the bottom edge behind the Logo Panel.

💡 NOTE

Align Calibration Scale to the bottom of the NAOMI sensor, so that the NAOMI sensor detects Calibration Scale properly.

52kVp, 5mAs
(Tube Distance: approx. 150cm(60"))

Recommended Tube Current : 100 mA
Recommended Exposure Time : 1/20 sec (0.05sec / 6 pulse)
The above equals to 5mAs.

*For any question, contact support center.

*When you cannot change the tube distance to 150cm, set the distance at farthest. X-ray factor may need to be adjusted at a different distance (ex.50kvp at 1m distance).

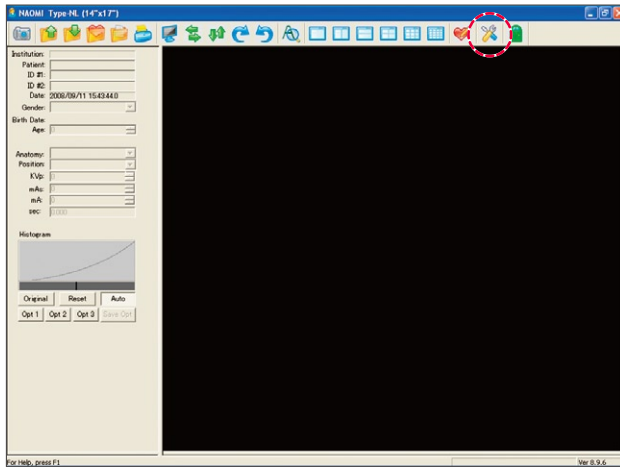

1. Click the Setup icon  to open Setup Window.

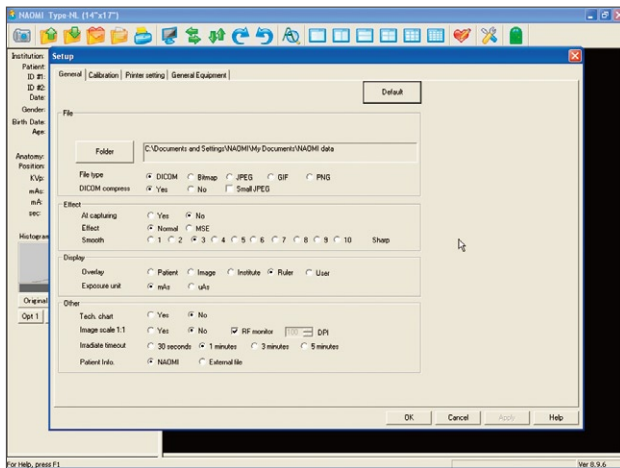

2. "Setup Menu" window appears.

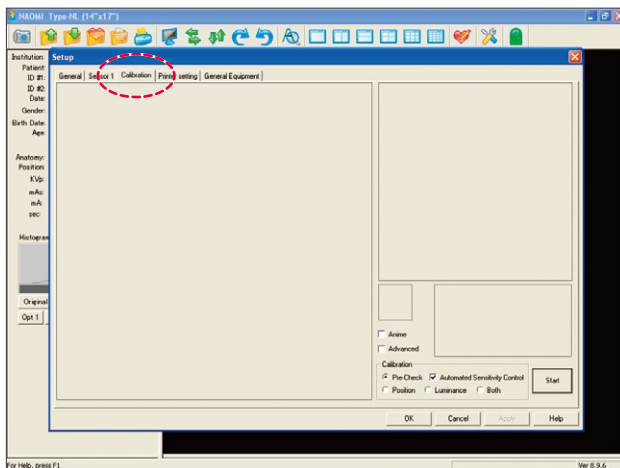

3. Click the Calibration tab.

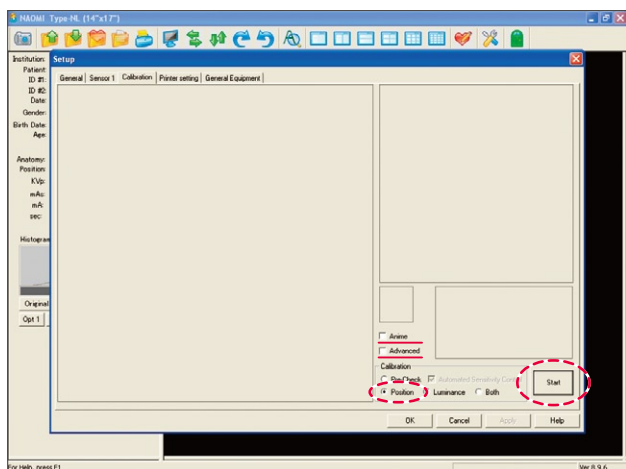

4. Select Position.

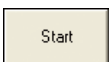
Click .

NOTE

Confirm there are no check marks on “Anime” and “Advanced”. They are for the factory inspections only.

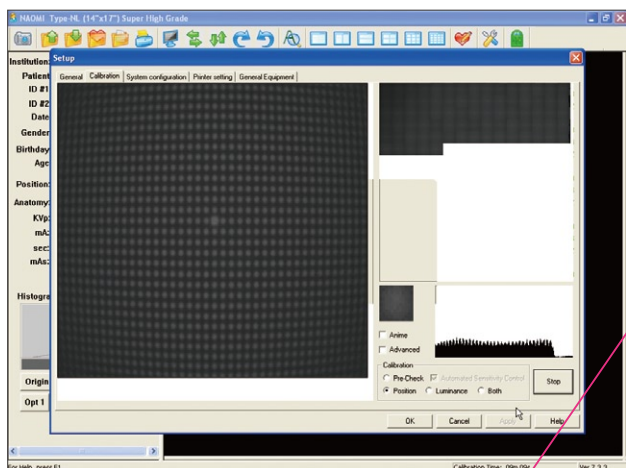

5. Positioning Calibration starts automatically.

NOTE

The processing time is displayed at the bottom of the window.

Error Message

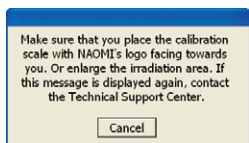
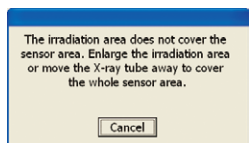
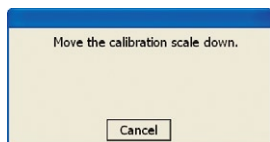
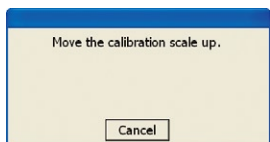
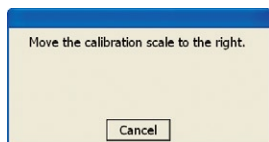
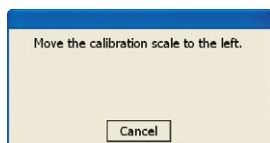
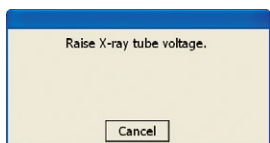
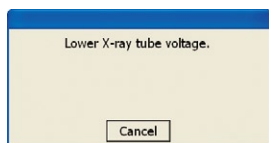

? If an error message appears, refer to the Calibration section in Troubleshooting Guide.

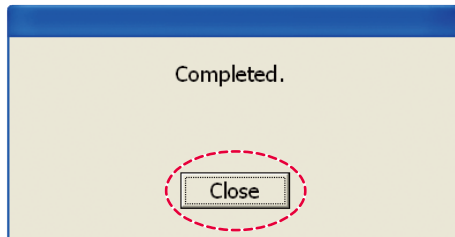

6. After Positioning Calibration is completed, the message, "Completed" appears.

Click .

NOTE

If the NAOMI software freezes or crashes (closes by itself) before this message appears on the screen, check if the map data is set on "Read - Only ". (Refer to Installation - 21 for details)

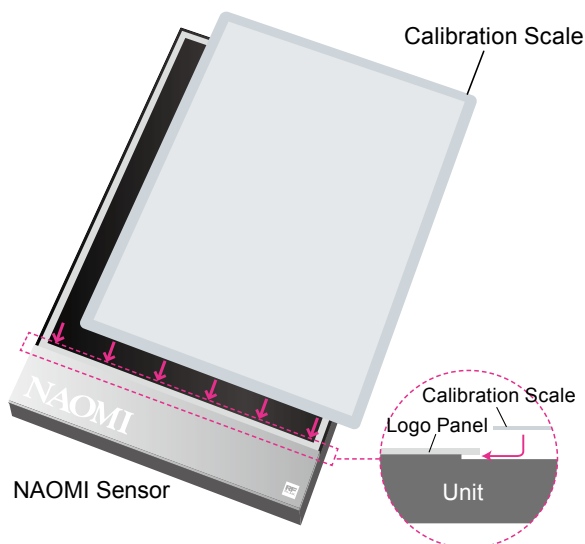

7. Remove Calibration Scale from the NAOMI sensor.



Handle the calibration scale with care to avoid any injuries or crease on the scale.

Now, proceed to Luminance Calibration.

Luminance Calibration is necessary to adjust the brightness level on each CCD in the NAOMI sensor. This will unify brightness level and create the image evenly adjusted. This process must be performed if you have completed Positioning Calibration or your image is similar to **Example Image A** or **Example Image B** on page : **Operation Check-06**.

REMOVE CALIBRATION SCALE.

Calibration Scale is used only for Positioning Calibration.
Calibration Scale must be removed before the Luminance Calibration process.

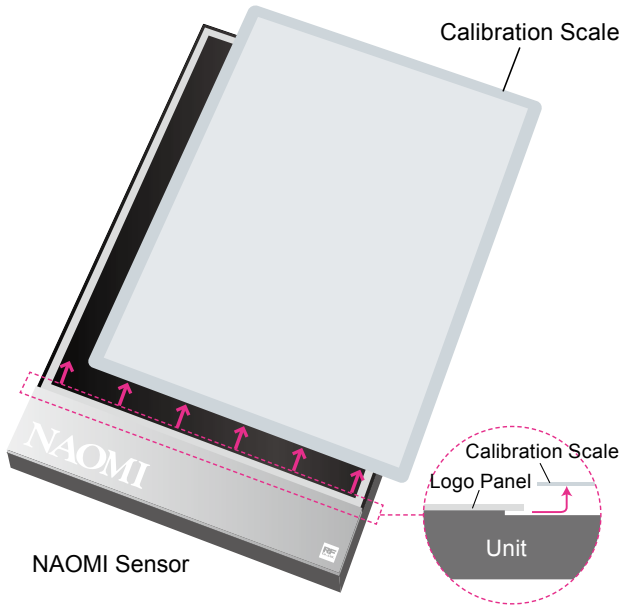

Handle the calibration scale with care to avoid any injuries or crease on the scale.

Now, it is ready for Luminance Calibration.

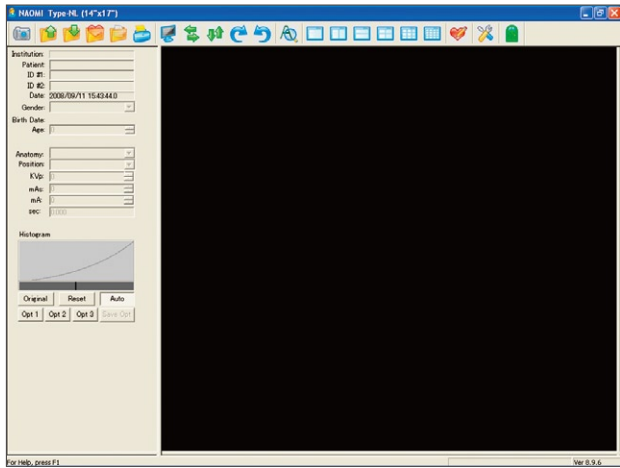

1. Click the Setup icon  to open Setup Window.

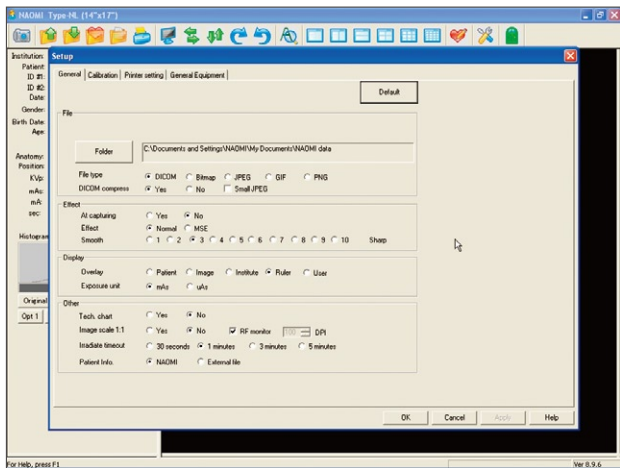

2. "Setup Menu" window appears.

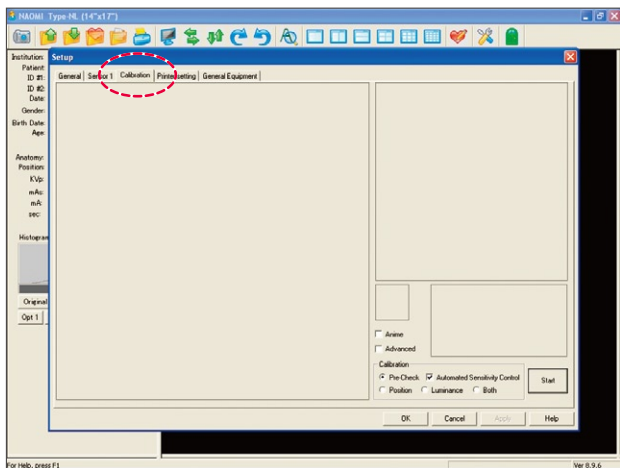

3. Click the Calibration tab.

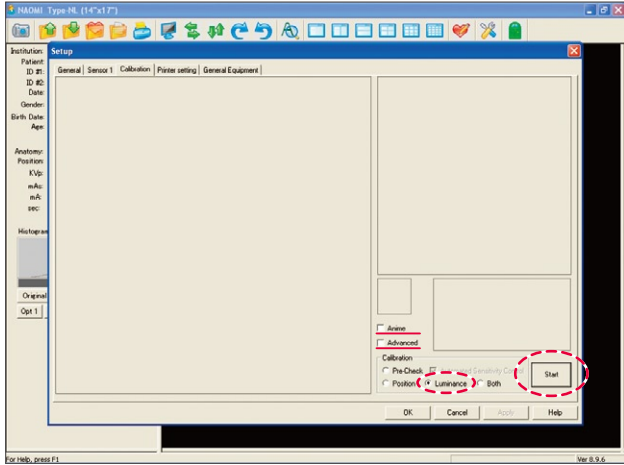

4. Select Lumiance.

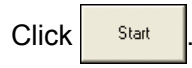

NOTE

Confirm there are no check marks on "Anime" and "Advanced".

They are for the purpose of shipment inspections only.

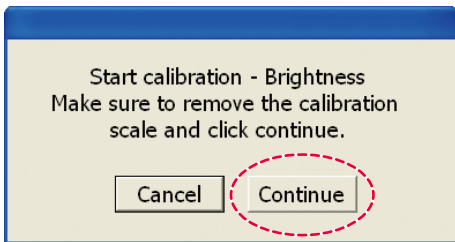

5. The message, "Start Calibration - Brightness" appears.

NOTE

Before proceeding further, please confirm that the Calibration Scale has been removed from the NAOMI sensor.

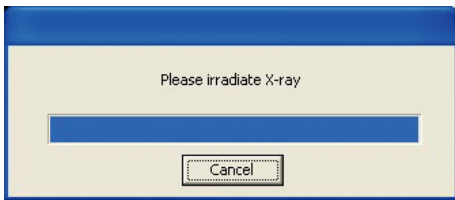

6. The message, "Please irradiate X-ray" appears to indicate that the software and NAOMI sensor is ready for exposure.

Irradiate x-ray before the time runs out.

NOTE

If the software starts reading data without irradiation, or it does not read data at all after irradiation, refer to Question1 of the Capturing X-Ray Image section in **Troubleshooting Guide**.

NOTE

The software starts counting down the remaining once the message appears on the screen. It alerts when the time is running out. It alerts 10 seconds remaining, 5 seconds remaining and when it is timed out.

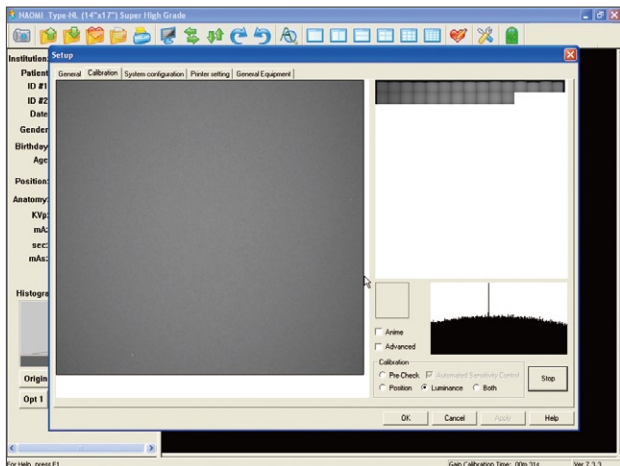

7. The software automatically starts calibrating each CCD sensor to adjust the brightness level.

Error Message

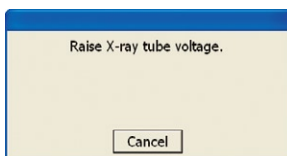
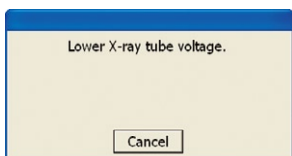

? If there is any error message on the screen, refer to the Calibration Section in Troubleshooting Guide.

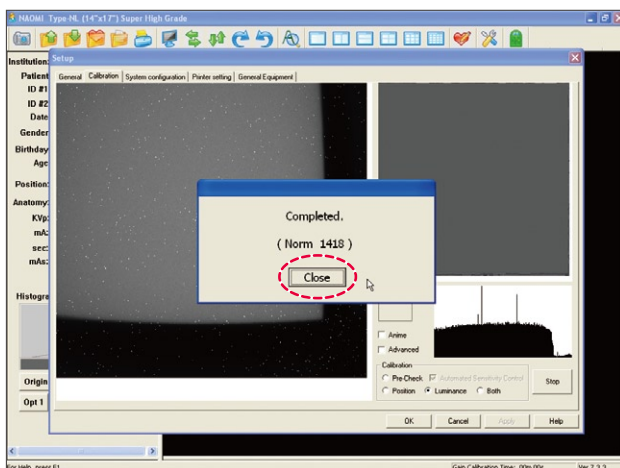

8. Once Luminance Calibration is successfully completed, the message, "Completed" appears.

Click .

NOTE

If the NAOMI software freezes or crashes (closes by itself) before this message appears on the screen, check if the map data is set on "Read - Only". (Refer to Installation - 21 for details)

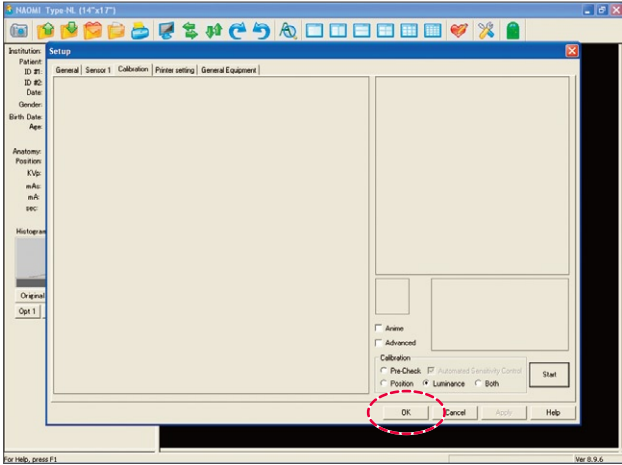

9. Click to save and close the Setup Menu.

NOTE

OK must be selected to save the adjustment made by this calibration process.

***Now, the calibration process has been completed.
It is ready for capturing x-ray images.***

Setup / Installation

Question 1 *The NAOMI sensor does not work.*

Is the Logo lights up on the Status Panel?

YES The unit recognizes the power and USB cable connections. Check if your computer recognizes the NAOMI sensor (check out if the NAOMI driver is recognized properly in Device Manager).

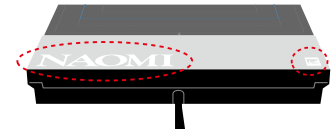

- NO**
- Confirm the power and USB cables are plugged into the NAOMI unit properly.
 - Unplug the power and USB cables once, and plug them back in to secure the connections.
 - Try a different USB port on your computer.
 - **Turn on the switch on the AC adapter.**
 - If the Logo still does not light up on the Status Panel, contact RF Technical Support.

Question 2 *I cannot install the software to my computer.*

What is your Operating System?

A: Windows XP / Vista / Windows 7

Check the CD-ROM drive. Check CD-ROM for any scratches or smudges. If the problem still exists, contact RF Technical Support.



How can I check what kind of Operating System I am running off of?

Right click "My Computer" ► Click "Property" ► Click "General" tab.
It lists the specification of Operating System your computer is based on.

Question 3 *Installation Wizard does not come up.*

The problem may be on CD-ROM or CD-ROM drive.
Contact RF Technical Support.

Question 4 *I want to uninstall the software.*

- A:** Insert the CD-ROM. Follow its steps to uninstall the software.
B: Go to "Control Panel" ▶ Click "Add or Remove Programs" ▶ Select "NAOMI" ▶ Follow the steps to complete the uninstallation process.

Question 5 *I want to reinstall the software.*

Refer to **Install the NAOMI software** in User's Guide. It will overwrite the existing software.

Question 6 *I want to install the software to my second computer.*

Contact RF Technical Support.

Question 7 *I cannot install the driver for the NAOMI sensor.*

Your computer must be compatible with USB 2.0.

A: Did the pop-up balloon appear on the screen when you plug in the USB cable?

YES Refer to the driver installation manual.

NO Install the driver manually.



- Right click "My Computer"
- ▼
- Click "Property"
- ▼
- Click "Hardware"
- ▼
- Click "Device Manager"
- ▼
- Click + next to "Universal Serial Bus Controllers"

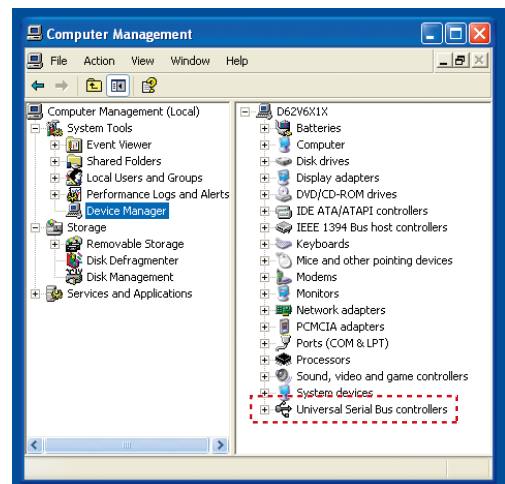

Is there any “unknown device” or “NAOMI Driver” with an explanation mark?

YES Update the driver.

- Right click on "Unknown Device" or "NAOMI Driver"
- ▼
- Select "Update driver"
- ▼
- “Update Driver” wizard shows up. Insert the CD-ROM into the CD-ROM drive.

NO Check the USB Connection. Change the USB port and check if there is any "Unknown Device" appears under "Universal Serial Bus Controllers". If the problem still exists, contact RF Technical Support.

Question 8 *I cannot find the map data folder.*

Refer to **Copy the NAOMI imaging data in User`s Guide** for its location.
(Page Installation - 16)

Capturing X-Ray Images

Question 1 *It starts reading the data without the irradiation.*

Is the Logo lights up on the Status Panel?

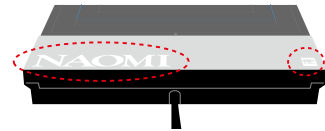

YES The unit recognizes the power and USB cable connections. Check if your computer recognizes the NAOMI sensor (check out if the NAOMI driver is recognized properly in Device Manager).

- NO**
- Confirm the power and USB cables are plugged into the NAOMI unit properly.
 - Unplug the power and USB cables once, and plug them back in to secure the connections.
 - Try a different USB port on your computer.
 - **Turn on the switch on the AC adapter.**
 - If the Logo still does not light up on the Status Panel, contact RF Technical Support.

A: Which does the title bar on the NAOMI software display?

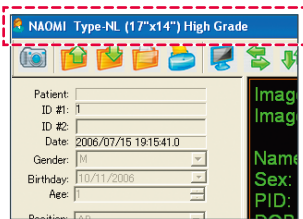

Your sensor type	Display
14"x17"	"NAOMI TYPE-NL (14"x17")"
11"x14"	"NAOMI TYPE-NS (11"x14")"
8"x10"	"NAOMI TYPE-SS (8"x10")"
Two or more NAOMI sensors connected	"Multi Sensor Mode"
★ USB is not recognized	"NAOMI (not connected)"

★ Does the title bar show "NAOMI (not connected)"?

Check the connections. Unplug the power cable and USB cable, and plug them back again after a minute. Then, restart the NAOMI software. Unplugging and plugging the cables do not solve the problem, check out if the computer recognizes the NAOMI driver properly (Refer to Setup / Installation, Question 7, on Page Troubleshooting-04). If still the software says "Not connected", try using a different power source.

B: Did you plug the USB Cable to the exactly same USB port when you installed the driver?

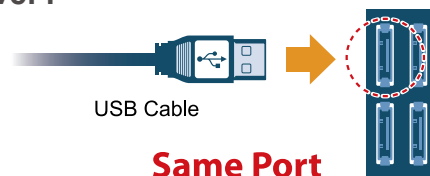

YES Update the driver. Refer to **Question 7** on **Setup / Installation Troubleshooting Guide**. (Page Troubleshooting-04)

NO Plug the USB Cable to the exact same USB port when you installed the driver.

Question 2 *It takes longer than 1 minute for images to come up to the screen.*

A: Are you using USB 2.0 port on your computer?

YES Close other applications you are running on the computer. The NAOMI system requires at least 2 GB memory on your computer. If the problem still exists, contact RF Technical Support.

NO Use USB 2.0 port. The NAOMI sensor must be used with USB 2.0 due to the data transfer speed.

Question 3 *It does NOT start reading the data AFTER the irradiation.*

Is the Logo lights up on the Status Panel?

YES The unit recognizes the power and USB cable connections. Check if your computer recognizes the NAOMI sensor (check out if the NAOMI driver is recognized properly in Device Manager).

NO

- Confirm the power and USB cables are plugged into the NAOMI unit properly.
- Unplug the power and USB cables once, and plug them back in to secure the connections.
- Try a different USB port on your computer.
- **Turn on the switch on the AC adapter.**
- If the Logo still does not light up on the Status Panel, contact RF Technical Support.

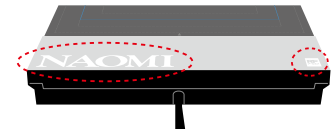

Question 4 *The message "Please irradiate X-ray" appears twice.*

Do not double click (click twice) the Camera icon. It needs to be clicked only once.

Question 5 *I took an x-ray image with a wrong ID number/name.*

A: Have you changed the DICOM information?

YES Even you change the ID number/name in DICOM Edit Mode, it does not change the folder name; thus, you need to transfer the image file to the right location for your future review. Go to the saving location, and to the folder with the wrong ID number/name. Copy the image file you captured with the wrong ID, and create a new folder with a right ID, then copy the image file there. You will be able to find the image data file under the right ID folder, next time you search for the image.

NO Refer to Software-21 to edit the wrong ID information to correct ID, first. Then, follow the above instruction to transfer the image file to the right saving location for your future review.

Question 6 Do you have the CD-ROM icon on the top?

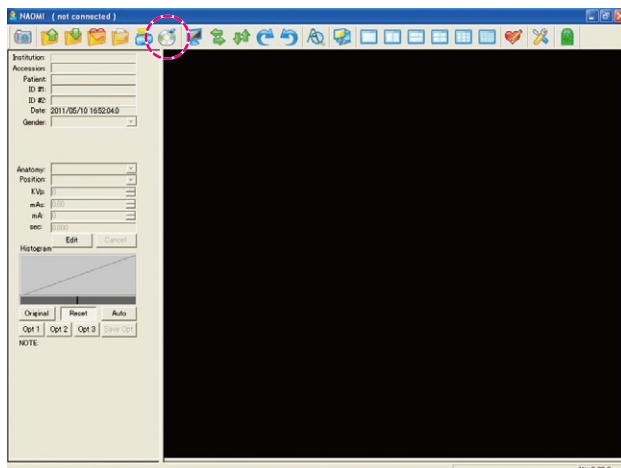

CD Burn Icon



If you do not have the CD-ROM icon on the top, follow below to enable the CD icon on your software.

1. Click on the area where you see the histogram graph on the left.

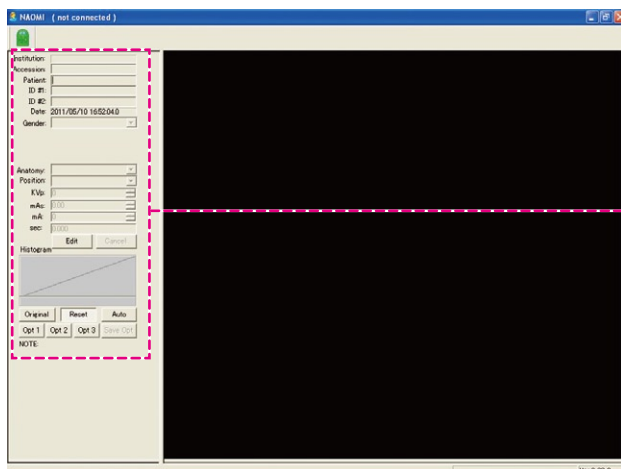

Click this area.

2. Press "Ctrl" and "F12" keys together, on your keyboard. Then, you will see the software becomes "MAINTENANCE MODE".

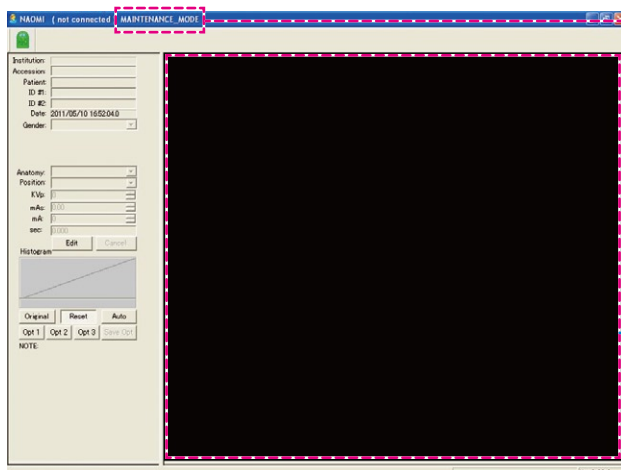

Shows you it is on MAINTENANCE MODE.

Click this area.

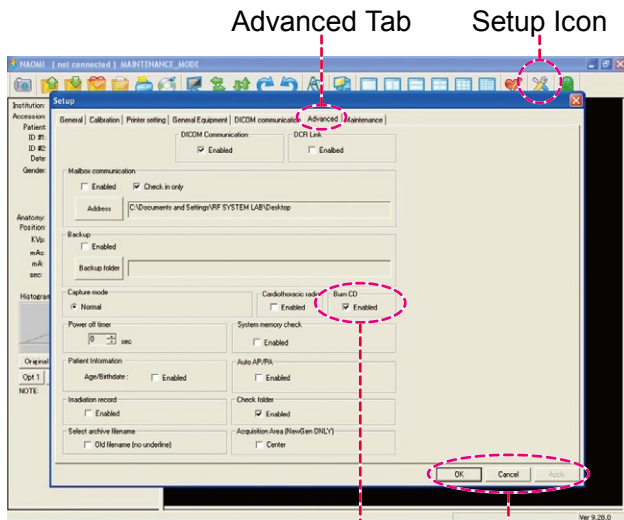

Advanced Tab Setup Icon

Check on Enabled under "Burn CD".

Click Apply and OK to apply the change.

3. Click on the area you see the image (Blue area on above). Then, all the icons displayed again. Click on the SETUP icon to go into the Setup Menu. Then, go to Advanced Tab. You will find the contents of "Burn CD". Check on "Enabled". Once you click Apply and OK, you will see the CD icon on top.

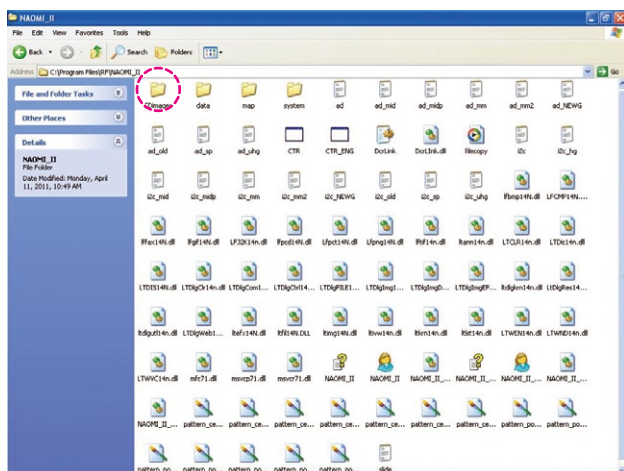

If you cannot burn the CD like this instruction shows, Please access to C:/Program Files/RF/NAOMI_II/, and make sure that you have the "CD image" folder in the program. If not, please uninstall and reinstall the software.

Calibration / QAP (Quality Assurance Program)

Positioning Calibration

Question 1 *I got the error message during Positioning Calibration.*

STEP 1 Check the following.

Is your irradiation area covering the whole active sensor area?

YES Proceed to **STEP 2**

NO Increase the tube distance.
Expand the irradiation area. (Refer to Sensor Area Troubleshooting Guide)

STEP 2 Check the following error message and restart Positioning Calibration again. (Or contact RF Technical Support. RF Staff will walk you through each step to correct the error message.)

Error A Irradiation area does not cover the sensor area. Enlarge the irradiation area or move the x-ray tube away to cover the whole sensor area.

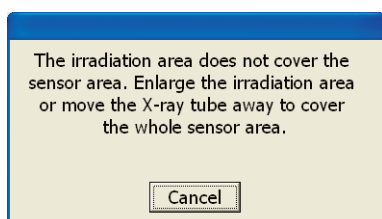

Click Cancel.
Increase the tube distance.
Expand the irradiation area.
Refer to **Sensor Area Troubleshooting Guide**.

Error B Make sure that you place the calibration scale with NAOMI's logo facing towards you. Or enlarge the irradiation area. If this message is displayed again, contact Technical Support Center.

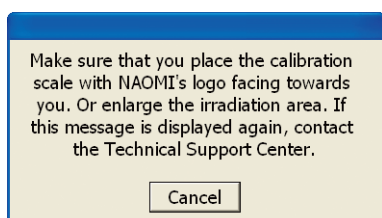

Click Cancel.
Confirm that you place Calibration Scale with the logos facing up.
Increase the tube distance.
Expand the irradiation area.
Or, refer to Sensor Area Troubleshooting Guide.
If the same message displayed again, contact RF Technical Support.

Error C Raise X-ray tube voltage.

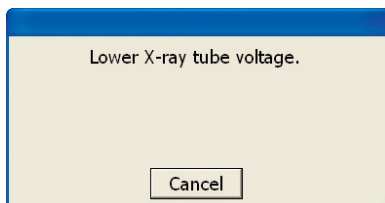

Click Cancel.
Increase the tube voltage by 2kVp and try again.

Increase the tube voltage by 2kVp until the error message shows to lower X-ray tube voltage.

After the error message shows to lower X-ray tube voltage, lower the tube voltage gradually.

If you still have the message to raise the tube voltage, contact RF Technical Support.

Error D Lower X-ray tube voltage.

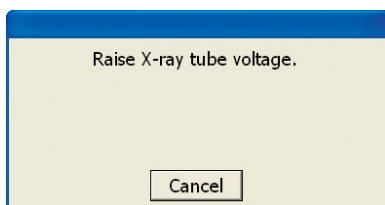

Click Cancel.
Decrease the tube voltage by 2kVp and try again.

Decrease the tube voltage by 2kVp until the error message shows to raise X-ray tube voltage.

After the error message shows to raise X-ray tube voltage, increase the tube voltage gradually.

If you still have the message to lower the tube voltage, contact RF Technical Support.

Error E Move the calibration scale to the right.

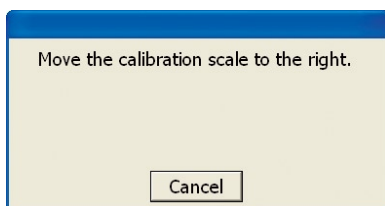

Click Cancel.
Press Calibration Scale itself slightly (**NOT the NAOMI sensor**) **to your right.**

If you cannot slide Calibration Scale or receive the same error message, contact RF Technical Support.

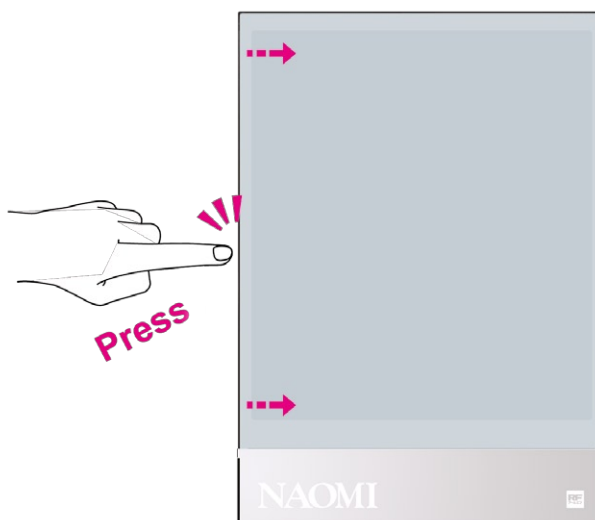

Error F Move the calibration scale to the left.

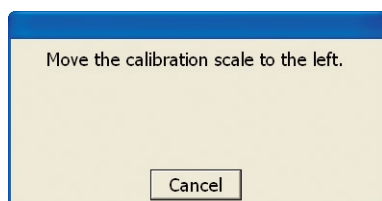

Click Cancel.
Press Calibration Scale itself slightly (**NOT the NAOMI sensor**) to your left.

If you cannot slide Calibration Scale or receive the same error message, contact RF Technical Support.

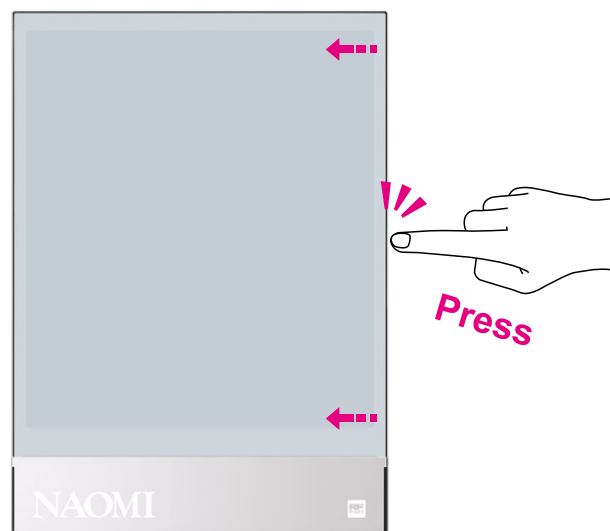

<Front >

Error G Move the calibration scale up.

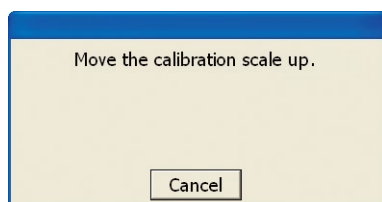

Click Cancel.
Contact RF Technical Support.

Error H Move the calibration scale down.

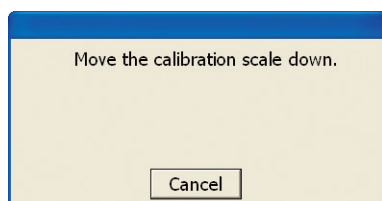

Click Cancel.
Contact RF Technical Support.

Luminance Calibration

Question 2 *I got the error message, during Luminance Calibration.*

STEP 1 Check the following.

Is your irradiation area covering the whole active sensor area?



Proceed to **STEP 2**



Increase the tube distance.
Expand the irradiation area. (Refer to Sensor Area Troubleshooting Guide).

STEP 2 Check the following error message and restart Luminance Calibration again.

(Or contact RF Technical Support. RF Staff will walk you through each step to correct the error message.)

Error

A

Raise x-ray tube voltage.

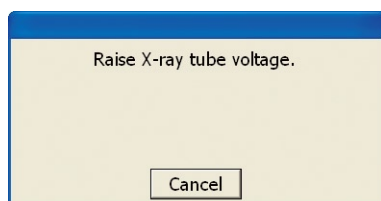

Click Cancel.

Increase the tube voltage by 2kVp and try again.

Increase the tube voltage by 2kVp until the error message shows to lower x-ray tube voltage.

After the error message shows to lower x-ray tube voltage, lower the tube voltage gradually.

If the tube distance is 100 cm / 39 inch, irradiation condition is 5 mAs, and the tube voltage reaches 100kVp, and you still have the message to raise the tube voltage, contact RF Technical Support.

Error **B** Lower X-ray tube voltage.

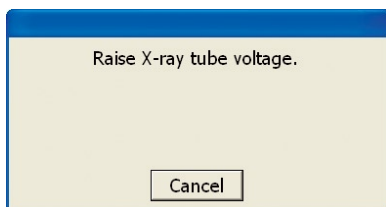

Click Cancel.
Decrease the tube voltage by 2kVp and try again.
Decrease the tube voltage by 2kVp until the error message shows to raise X-ray tube voltage.

After the error message shows to raise X-ray tube voltage, increase the tube voltage gradually.

If the tube distance is 100 cm / 39 inch, irradiation condition is 5 mAs, and the tube voltage reaches 100kVp, and you still have the message to raise the tube voltage, contact RF Technical Support.

Open / Save Images

Question 1 *I cannot save images.*

A: Is there any letter in the file name, which is not supported by the NAOMI software?

The NAOMI software supports the following letters.
0-9, A-Z (UPPER CASE), a-z (lower case), _ (underscore), - (hyphen)

YES Rename the file name.

NO Contact RF Technical Support.

B: Hard disk may be full.

Clean up the hard disk, or increase the hard disk space.

Question 2 *I cannot open the saved images.*

A: Is there any letter in the file name, which is not supported by the NAOMI software?

The NAOMI software supports the following letters.
0-9, A-Z (UPPER CASE), a-z (lower case), _ (underscore), - (hyphen)

YES Rename the file name.

NO Check the file type. Refer to C:(file types).

B: The file may be broken.

You cannot open a broken file. Contact RF Technical Support.

C: The file type is not supported by the NAOMI software.

The NAOMI software supports the following file types.
DICOM, BMP (bitmap), JPEG, PNG, GIF

Question 3 *I don't know where to find the save image.*

A: Click Setup Icon . Select General tab.
Under “file”, the file location is listed.
Refer to “How to Change Setting” for details.

Crash

Question 1 *The NAOMI software crashes. (closes by itself)*

A: Check the Map folder.

Map folder location `c:/Program Files/RF/NAOMI_II/map`

Do you have the following three files in your map folder?

① **affine** ② **gain** ③ **gpoint**



Check the property of these three files.
Confirm if Read-Only is checked.
If it is checked, remove the checkmark.
If the problem still exists, contact RF Technical Support.



Copy the map data to your map folder from Data CD-ROM.
Refer to How to copy map data to your computer Page : **Installation 16-21**

B: The file you are trying to open may be broken.

You cannot open the broken image file with the NAOMI Software. Contact RF Technical Support.

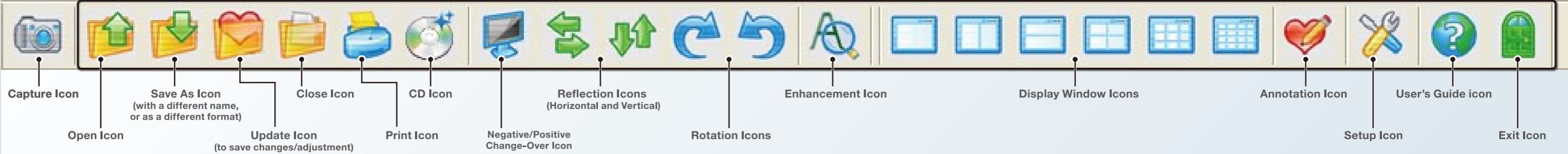

How to Adjust the Images...



Adjust Gamma Setting

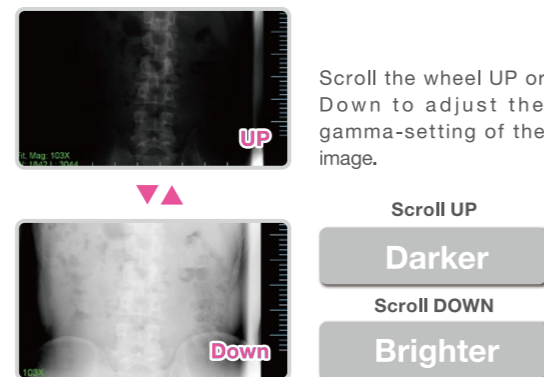

Zoom In & Out

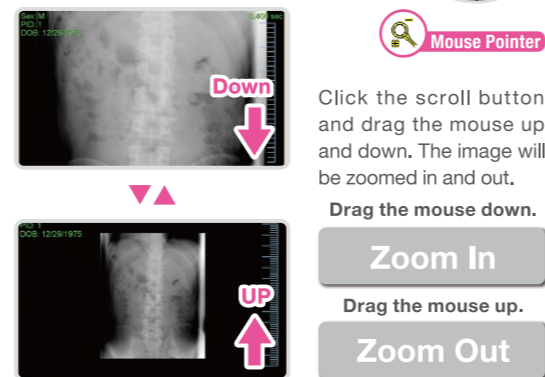

Adjust the brightness and contrast



Useful Function

Enhancement function.

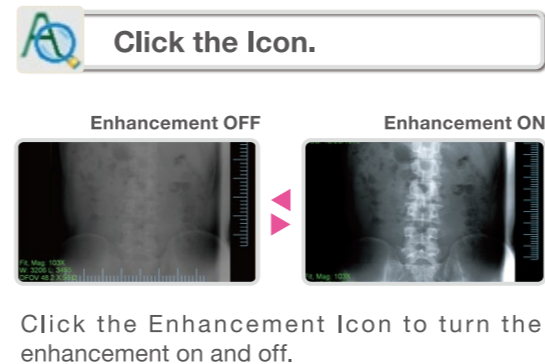

How to Save the Adjustments...

- Q** I want to save the changes of brightness and/contrast.
- A** Save the changes by clicking the Update Icon.

After adjusting the brightness and contrast, click the Update Icon to save the changes.

The changes will be overwritten on the image file.
* To display the saved adjustment condition, click on the "Original" button under the histogram graph on the left of the image.

- Q** I want to save the images in a different format.
- A** Click on the Save As Icon to save it in a different format.

- 1 Click the Icon.

Click the Save As Icon on the menu bar.

- 2 Select the file format and save.

Select the file format under "Save as type", and enter the "file name".

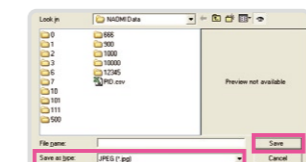

After entering the file name, click "Save" to save it in the selected format.

How to Open the Captured Images...

- 1 Click the Icon

Click the Open Icon on the menu bar.

- 2 Select the image file.

Double click the ID folder.

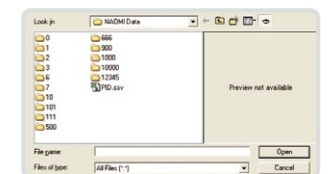

Select the image file(s) you want to open, and click Open.

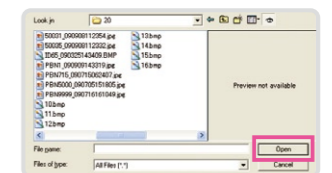

The selected image(s) is opened and displayed.

How to find the ID folder easily...

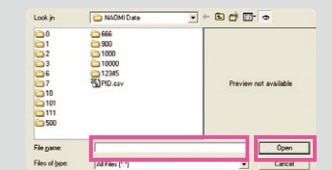

Enter the ID number (or ID name) in "File name", and click "Open".



Capture icon

User's Guide icon

Before capturing x-rays...

Start the NAOMI software before capturing x-rays.

Starting up the NAOMI software.

Double click on the "NAOMI" icon on your desktop.

* To install the NAOMI software, refer to User's Guide Installation Part.

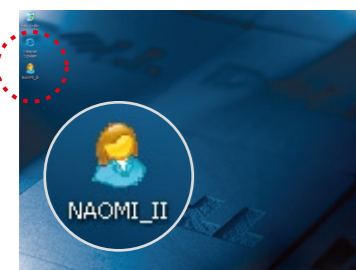

The software opens.

Recommended

When you feel the capturing process becomes slow...

Close the displayed images to maximize your computer's memory capacity.

It slows your computer processing while many images are displayed.

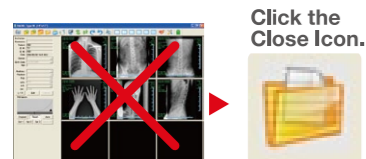

Be prepared to capture next images, by closing the displayed images.

How to capture x-ray images with the NAOMI.

1 Click the icon.

Click the **Camera** icon on the menu bar.

2 Enter the Patient Information.

Enter the ID number, or select the ID from the existing list.

The ID is required.

Without entering the ID, the capturing buttons (Single or Series) are not activated.

You may want to enter the necessary information for the Sub ID, patient's name, gender, age, date of birth, anatomy, position, and/or the x-ray factors.

Select the sensor area.

Capturing size:

14x17

For lumber, chest, etc
Imaging area: 342mm x 422mm max.

11x14

For cervical, head, etc
Imaging area: 254mm x 312mm max.

8x10

For hands, foot, etc
Imaging area: 254mm x 206mm max.

* The listed sizes may differ from film sizes.

Patient Information Window

Select/Register ID

* ID: 1

Sub ID: _____

Accession: _____

Patient: _____

Gender: _____

Birth date: 9/ 5/2011 Age: 0

Filename: _____

Sensor area: 14x17 11x14 8x10

Anatomy: _____

Position: _____

Tech. indication: Exposure in mAs

KVp: 0 mAs 0

mA: 0

sec: 0

Check in

Cancel

Single Series

3 Click the capture button.

Click one of the **capture** buttons.

Single Series

Single... To capture one x-ray.
Series... To capture multiple x-rays for the single patient.

POINT!

Make sure to complete positioning of a patient before clicking the capture button.

4 Irradiate an x-ray.

Once the message, "Please irradiate an x-ray" shows up, the computer and the NAOMI sensor are ready for detecting an x-ray.

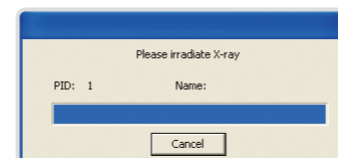

Irradiate an x-ray before the countdown message disappears.

After several seconds, the x-ray image will be displayed on the computer monitor.

(The displayed image has been automatically saved in the computer.)

Refer to User's Guide for more details (Software Part, page 01-14).

Q I cannot click the capture button!
I cannot capture the x-ray image!

1 Close the NAOMI software once.

2 Check out the LEDs light up for the Power and USB Status Lamps on the NAOMI main unit.



When the LED for the USB Status Lamp is not on...

Check Point A Make sure if the USB cable for the computer and the NAOMI main unit is firmly connected. (Unplug it and plug it back again to make sure the stable connection.) Make sure if the USB cable is not twisted or bended.

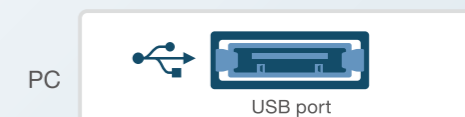

When the LED for the Power Status Lamp is not on...

Check Point B Is the power indicator on the power adapter box on? Make sure the switch on the power adapter (AC adapter) is on.
Is the power cable connected to the NAOMI main unit? Is the power cable connected firmly to the power source outlet? (Unplug and plug it back again to make sure the connection.)

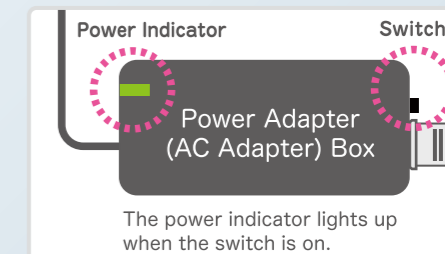

3 Restart the NAOMI software, and check out if you can click the capture buttons (Single or Series) once entering the ID information.

Call our Technical Support Team if above does not solve the problem.

How to correct when I captured the image with a wrong ID?

Premise Below is the process to change the wrong ID: 5106, to the correct ID: 5105.
 "Click" below means a left click.

1 Register a correct ID.

* Required only when the correct ID is a new ID. If it is an existing ID, skip this process.

Click the "Camera" icon.

- Type in the correct ID: 5105. Type in the information (i.e. name etc) if necessary.
- Click "Check in" to register a correct ID and its related information.
- Click "Cancel" to close the menu. (Because no need to capture another x-ray image)

2 Correct the wrong information on the captured image.

Click the Open Icon, to open the captured image with a wrong information.

- Open the captured image file from the wrong ID folder: 5106.
 *Refer to User's Guide for details about how to open the captured images.

- Click "Edit" button* to revise wrong information, changing the wrong ID: 5106, to the correct ID: 5105. You may want to edit other information like "Name" or "Anatomy", too.

- Click "Update" button to save the changes.

Close the displayed image(s), which you have just revised the information of.

* Repeat this process when you have multiple images with the wrong ID.

3 Relocate the image file(s).

* Required only when the wrong information was the ID, because the image(s) is/are saved under the ID number or ID name.

Click "Open" Icon.

- Click the wrong ID folder: 5106, and click "Open".

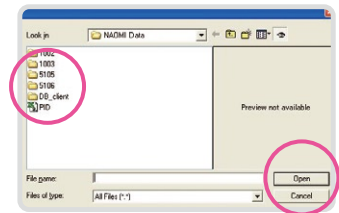

- Select the image file(s) and click.

* Pressing the "Ctrl" button on the keyboard allows you to select multiple image files together.

- Right click on the selected image files, and click on "Cut" in the list.

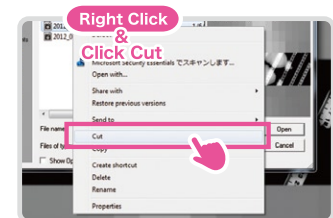

- Click on the root directly.

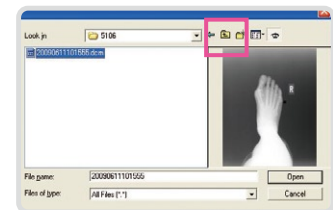

- Click on the correct ID folder: 5105, and click "Open".

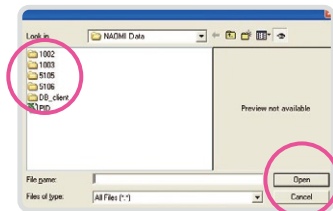

- Paste the image files. Right click on the framed area of the window, and click on "Paste" in the list menu.



Relocation completed. The image files are now saved under the correct ID folder.

* No "Edit" icon?



Setup Icon

Go to "Setup" menu by clicking Setup Icon. Check on "Enabled" for "DICOM edit mode" under "General" Tab.

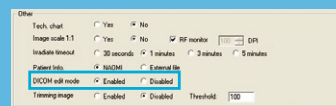

Safety Check

For Long-Term Use

Wipe off dirt with a soft, dry cloth. If the dirt is heavy, squeeze a wet towel well and wipe off the dirt. You may use alcohol but do not use any other cleaning substance.

Regular Check

Please check the followings for each three months for your safety.

1. Any screws are not loose.
2. No cracks or fracture on the main unit.
3. The DC-in Jack and USB ports have not become loose.
4. Power Lamp illuminates in green when the AC Adapter is connected.
5. USB Lamp illuminates in red when the USB cable is connected.

RF Technical Support Center

Contact the RF Technical Support Center if you have any inquiries about the product. Call us or fax your inquiries. Technical experts will contact you and answer your questions.

How to contact RF Technical Support Center?

■ **By Phone:**

1-800-759-9557

from USA

1-866-742-5610

from Canada

1-800-151-319

from Australia

+81-26-225-7744

from other countries

■ **By Fax:**

Copy the Request Form on the next page and fax it to us. You may upload the images for your inquiries or questions.

1-800-799-9895

from USA

1-866-742-5611

from Canada

1-800-151-320

from Australia

+81-26-225-7747

from other countries

■ **By E-mail:**

os@rfssystemlab.com

■ **By Website:**

www.rfssystemlab.com

Technical Support Request Form

When you have troubles with the product, or when you cannot acquire the proper images, please let us know the following information.

Your information

				Date	
Purchase Date	Year	Month	Date	Address	
Office Name				TEL	
Doctor's Name				FAX	
Serial No				Emal:	

Description of the trouble

What trouble do you have?	<input type="checkbox"/> Setup/Installation	<input type="checkbox"/> Calibration	<input type="checkbox"/> Image	<input type="checkbox"/> Other
Since when have you had the problem?	From Today /		Day(s) Ago	
Frequency of the problem				Times

Irradiation Setting - If the trouble is about Calibration or Image, provide us the following information.

Tube Distance	Feet Inches /				m	cm
Tube Voltage	kVp	Tube Current		mA		
Irradiation Time	Second(s) /		Pulse			
Irradiation Condition	mAs					
X-Ray Irradiator Manufacturer Name						
Type of Irradiator						

*Please circle one from A to E, when the trouble is regarding to the image quality.

Contrast	(A. Very Good B. Good C. Fair D. Poor E. Very Poor)
Brightness	(A. Very Good B. Good C. Fair D. Poor E. Very Poor)
Sharpness	(A. Very Good B. Good C. Fair D. Poor E. Very Poor)
Dynamic Range	(A. Very Good B. Good C. Fair D. Poor E. Very Poor)
The Part of Focus	(A. Bone B. Abdomen C. Chest D. Extremities)
Bone	(A. Very Good B. Good C. Fair D. Poor E. Very Poor)
Abdomen	(A. Very Good B. Good C. Fair D. Poor E. Very Poor)
Lung Field	(A. Very Good B. Good C. Fair D. Poor E. Very Poor)
Cranial Bone	(A. Very Good B. Good C. Fair D. Poor E. Very Poor)
Extrimeties	(A. Very Good B. Good C. Fair D. Poor E. Very Poor)
Comment	

FAX: 1-800-799-9895 (from US) **1-866-742-5611** (from Canada)
1-800-151-320 (from AUS) **+81-26-225-7747** (from other countries)

Technical Support Request Form

When you have troubles with the product, or when you cannot acquire the proper images, please let us know the following information.

Your information

Purchase Date	Year	Month	Date
Office Name			
Doctor's Name			
Serial No			

Date	
------	--

Address	
TEL	
FAX	
Emal:	

Description of the trouble

What trouble do you have?	<input type="checkbox"/> Setup/Installation	<input type="checkbox"/> Calibration	<input type="checkbox"/> Image	<input type="checkbox"/> Other
Since when have you had the problem?	From Today /		Day(s) Ago	
Frequency of the problem				Times

Irradiation Setting - If the trouble is about Calibration or Image, provide us the following information.

Tube Distance	Feet Inches /				m	cm
Tube Voltage	kVp	Tube Current		mA		
Irradiation Time	Second(s) /		Pulse			
Irradiation Condition	mAs					
X-Ray Irradiator Manufacturer Name						
Type of Irradiator						

*Please circle one from A to E, when the trouble is regarding to the image quality.

Contrast	(A. Very Good B. Good C. Fair D. Poor E. Very Poor)
Brightness	(A. Very Good B. Good C. Fair D. Poor E. Very Poor)
Sharpness	(A. Very Good B. Good C. Fair D. Poor E. Very Poor)
Dynamic Range	(A. Very Good B. Good C. Fair D. Poor E. Very Poor)
The Part of Focus	(A. Bone B. Abdomen C. Chest D. Extremities)
Bone	(A. Very Good B. Good C. Fair D. Poor E. Very Poor)
Abdomen	(A. Very Good B. Good C. Fair D. Poor E. Very Poor)
Lung Field	(A. Very Good B. Good C. Fair D. Poor E. Very Poor)
Cranial Bone	(A. Very Good B. Good C. Fair D. Poor E. Very Poor)
Extrimeties	(A. Very Good B. Good C. Fair D. Poor E. Very Poor)
Comment	

FAX: 1-800-799-9895 (from US) **1-866-742-5611** (from Canada)
1-800-151-320 (from AUS) **+81-26-225-7747** (from other countries)

NAOMI Technique Indication Chart

This technique chart is based on the sensor sensitivity, 500.

By doubling the sensor sensitivity, it is possible to reduce the value of mAs by a half or the value of KV by 10%.

The high exposure setting may cause the partial saturation on the imagery data, which exceeded the limit of CCD sensitivity.

It is possible to increase the sensor sensitivity to the maximum, however it may increase the noise saturation on the image.

■ **Thorax** (setting at 100cm (39-inch) of the tube distance)

Indication of kVp and mAs setting

Tube Distance	inch	39	35	31	28	24	20
	cm	100	90	80	70	60	50
mAs		5	4	3	2	2	1

Indication of kVp setting

Thickness	cm	2	4	6	8	10	12	14	16	18	20	22	24	26	28	30
kVp	Grid-	50	53	56	59	62	65	68	71	74	77	80	80	80	80	80
	Grid+	70	73	76	79	82	85	88	91	94	97	100	100	100	100	100
mAs		2	2	2	2	2	2	2	2	2	3	3	4	5	6	7

※  Area: Follow the settings on "Grid+"

(setting at 200cm (78-inch) of the tube distance)

Indication of kVp and mAs setting

Thickness	cm	2	4	6	8	10	12	14	16	18	20	22	24	26	28	30
kVp	Grid-	70	73	76	79	82	85	88	91	94	97	100	100	100	100	100
	Grid+	90	93	96	99	102	105	108	111	114	117	120	120	120	120	120
mAs		2	2	2	2	2	2	2	2	2	3	3	4	5	6	7

※  Area: Follow the settings on "Grid+"

■ **Extremities • Bone • abdomen** (setting at 100cm (39-inch) of the tube distance)

Indication of kVp and mAs setting

Thickness	cm	2	4	6	8	10	12	14	16	18	20	22	24	26	28	30
Grid-	kVp	52	54	56	58	60	62	64	66	68	70	72	74	76	78	80
	mAs	2	3	4	5	6	7	8	9	10	11	12	13	14	15	16
Grid+	kVp	60	60	60	60	60	60	60	60	60	65	70	75	80	85	90
	mAs	2	8	14	20	26	32	38	44	50	50	50	50	50	50	50

※  Area: Follow the settings on "Grid+"

NOTE:

* Adjust mAs setting, depending on the tube distance. With half tube distance, mAs setting will be 1/4.

For example...

Tube Distance	inch	39.4	34.4	31.5	27.6	23.6	19.7
	cm	100	90	80	70	60	50
mAs		20	16	13	10	7	5

Grid = +10~20kvp
or mAs x 2 or more

* When using a Grid, increase the kVp as shown.

* When you select Grid Icon, the recommended irradiation condition will be set accordingly by the software

